

METAL SHEETS

Parts with same color are duplicates

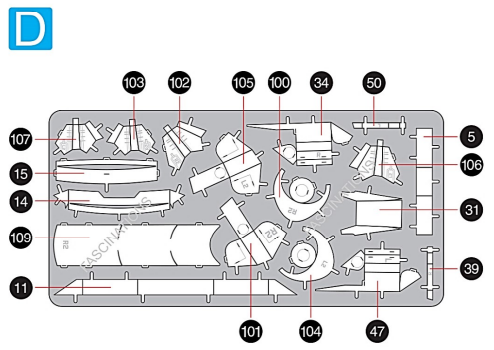

Metal Earth
Premium Series

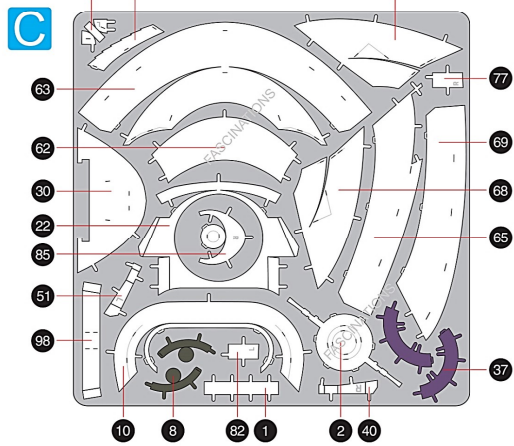
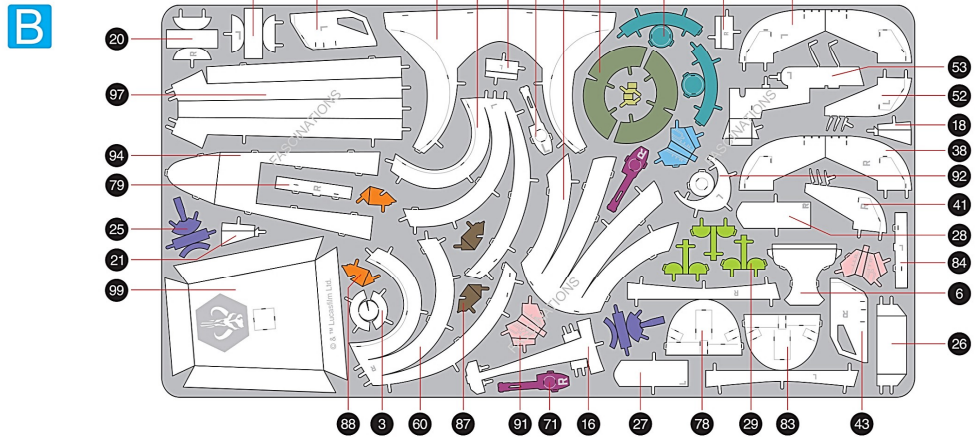

It is highly recommended that you visit www.metalearth.com/360/ICX232 to see the completed model before assembling your own

STAR WARS
www.starwars.com
© &™ Lucasfilm Ltd.

ICX232 Boba Fett's Starfighter

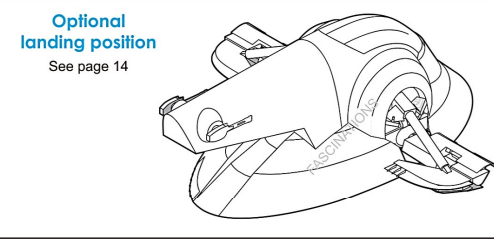
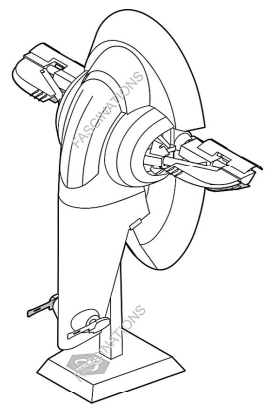

TO CREATE THE BEST CONNECTIONS

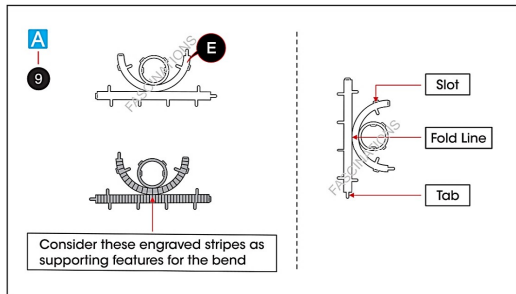

- Legends:**
- E** Engraved/Color side
 - NE** Non-engraved/Silver side
 - Hand icon** Attention point
 - Blue circle** Insert tab and bend 90 degrees
 - Green triangle** Insert tab and twist 90 degrees
- Recommended tools:**
- Wire cutters: helpful for taking parts from the metal sheets.
 - Tweezers or needle nose pliers: helpful for folding parts, bending and twisting tabs.
- Assembly tip:**
If needed, slightly twist tabs to hold parts together then untwist and bend them down for a nice finish

ASSEMBLY STEPS

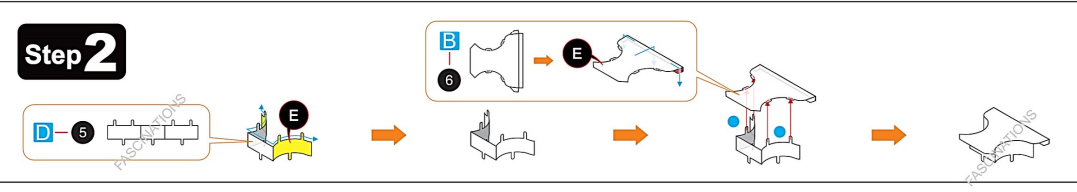
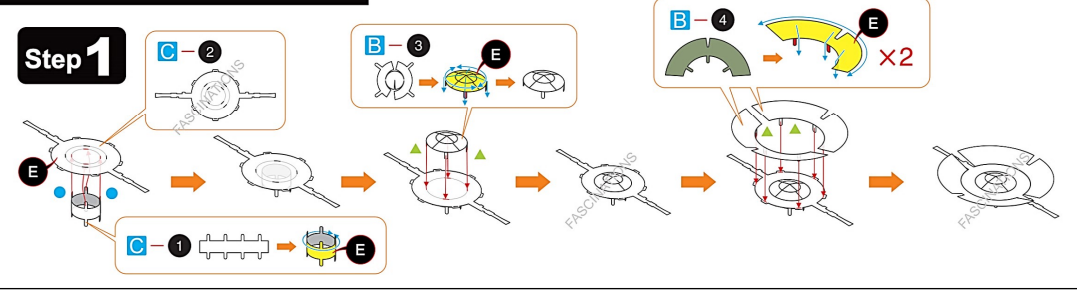

! In order to avoid possible injury from sharp edges, please carefully discard the metal sheets after parts have been removed

Step 3

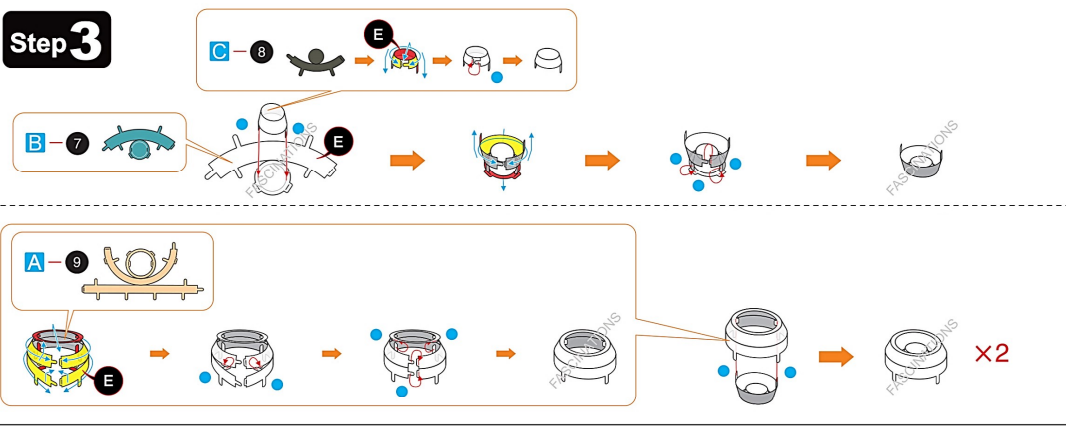

Step 4

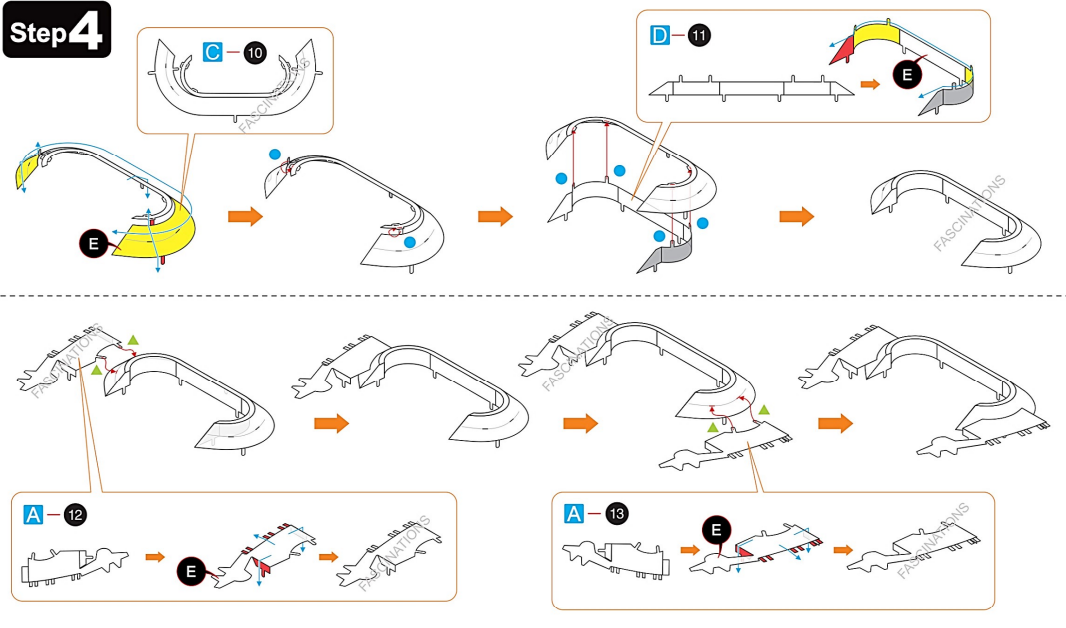

Step 5

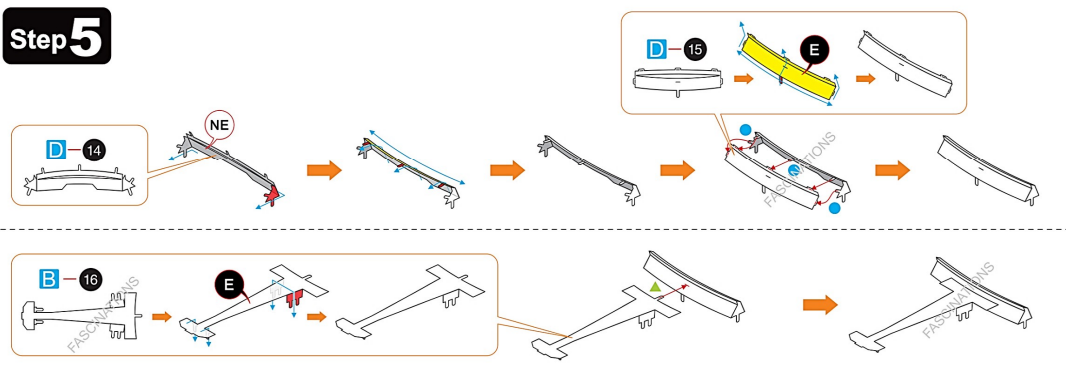

Step 6

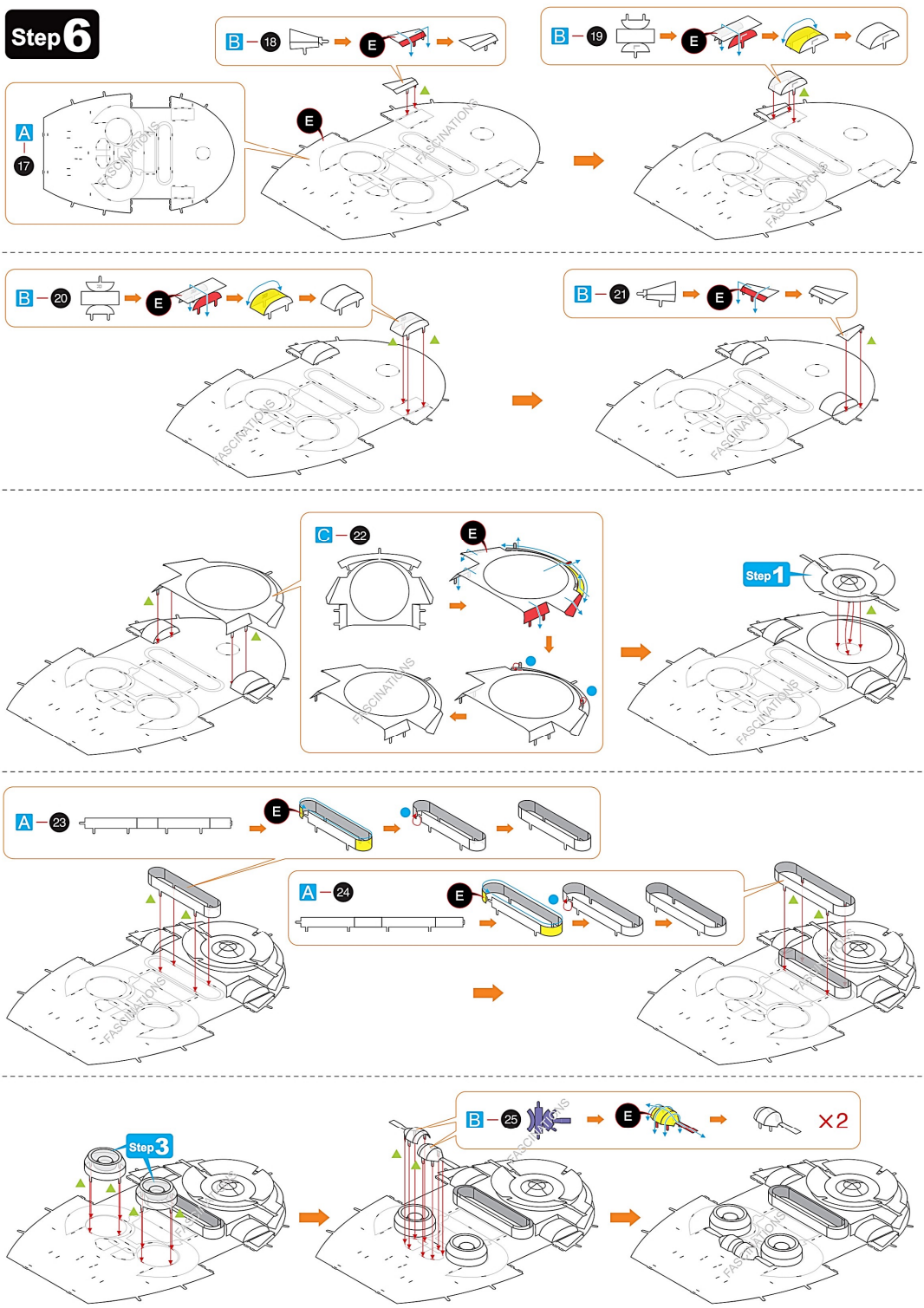

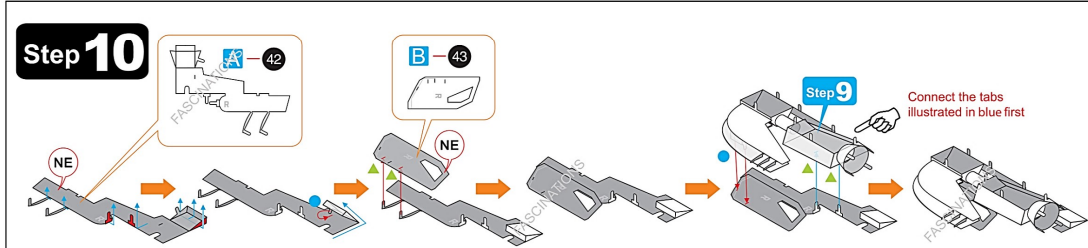
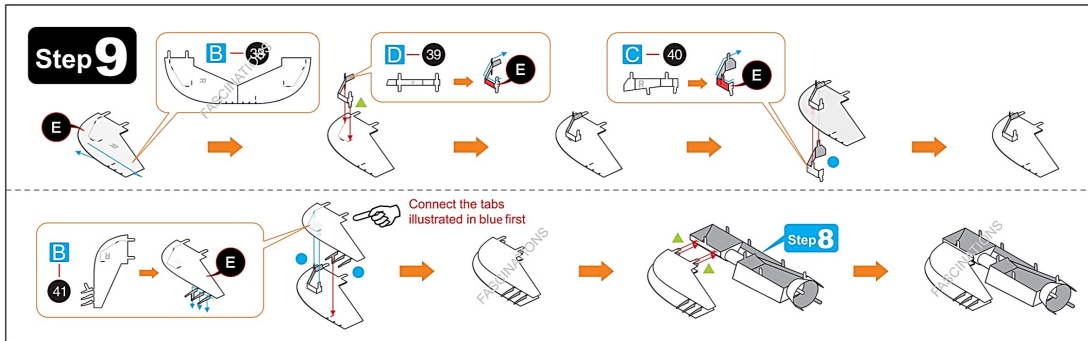
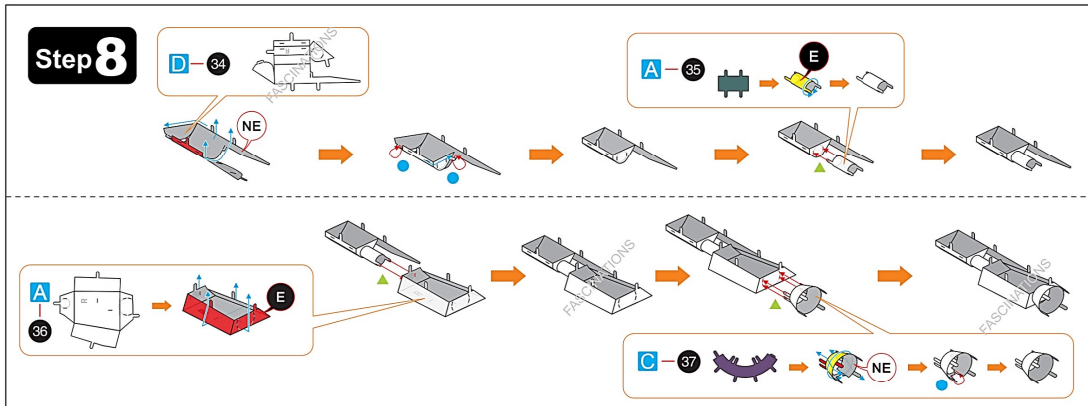
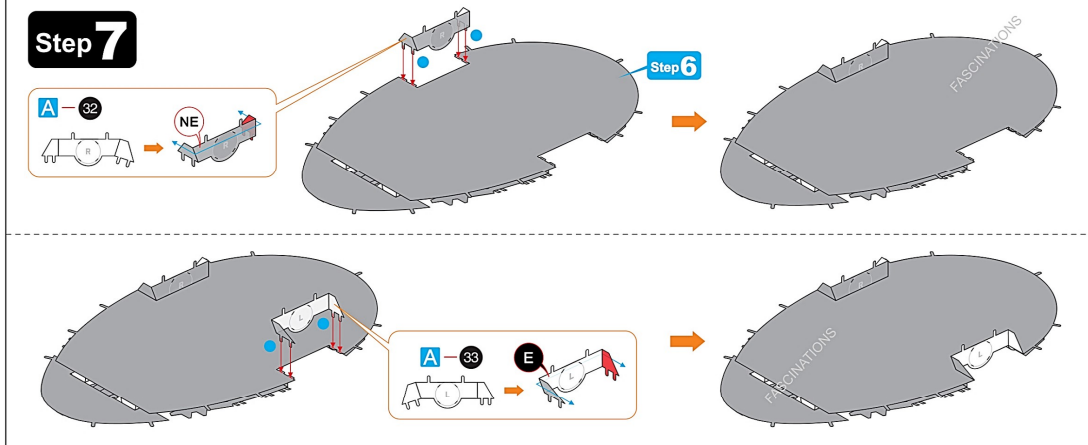
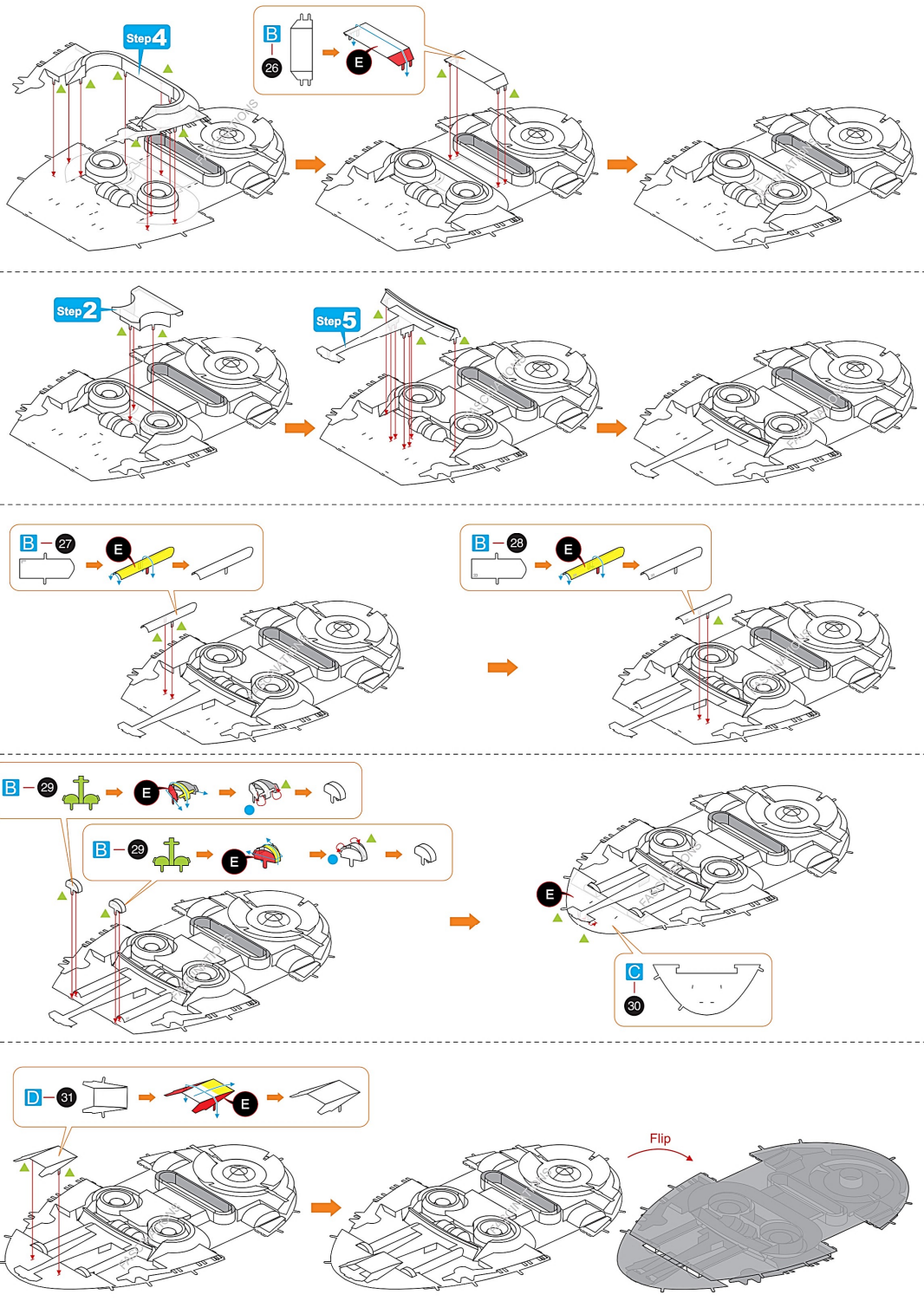

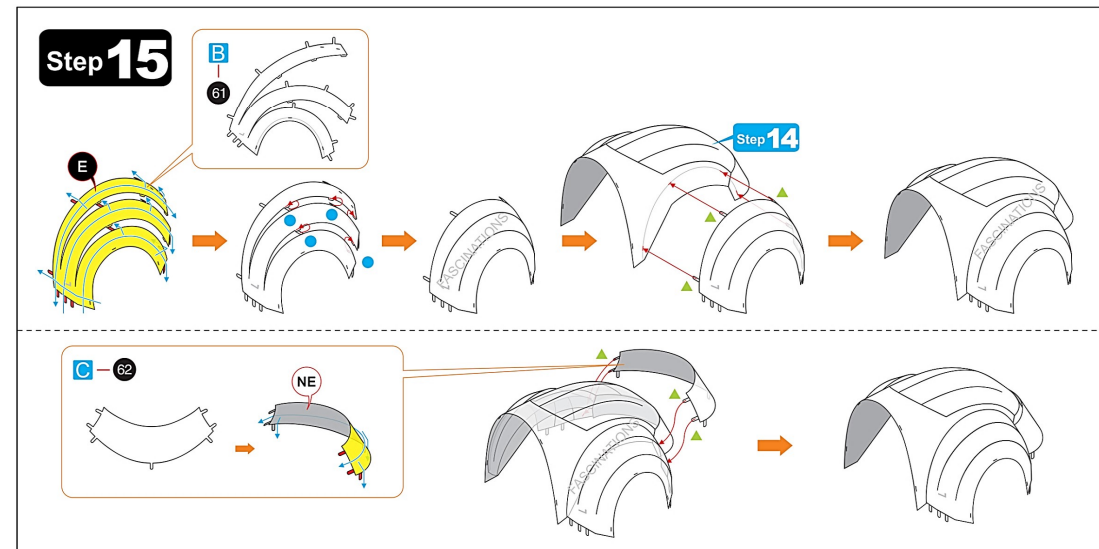
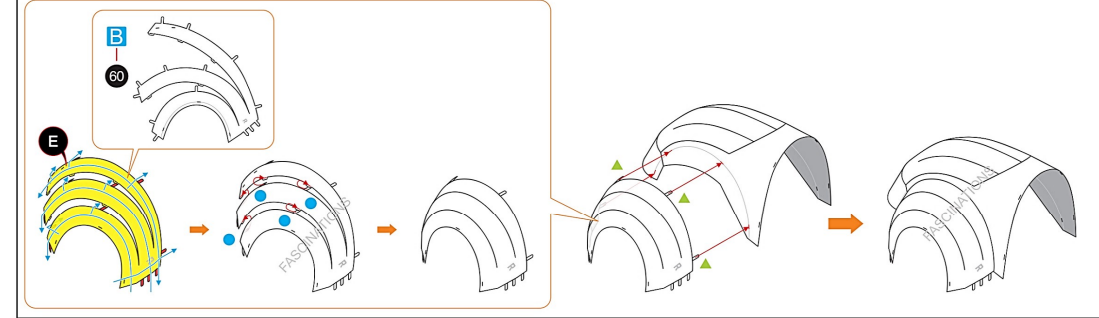
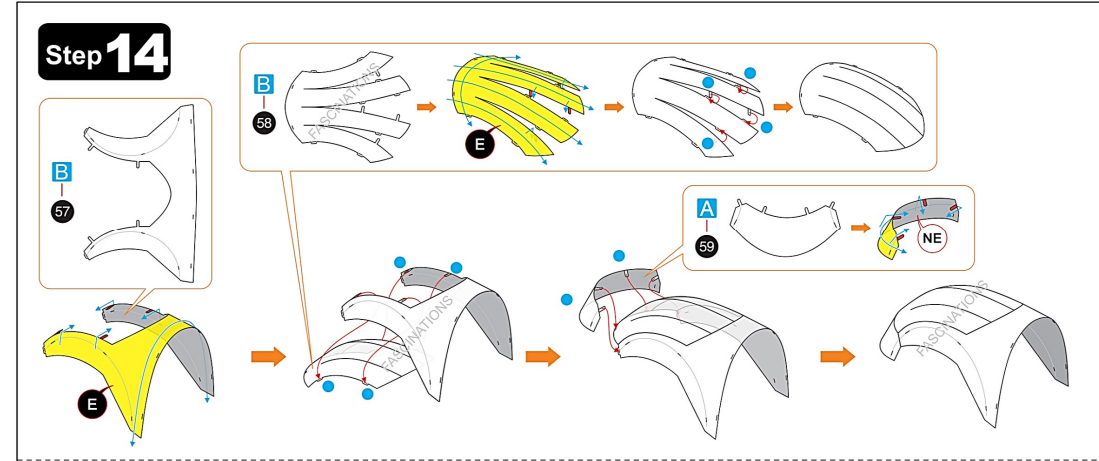
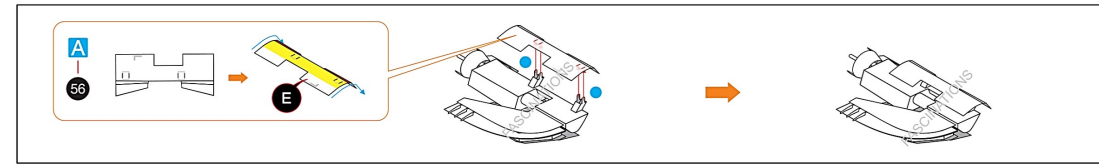
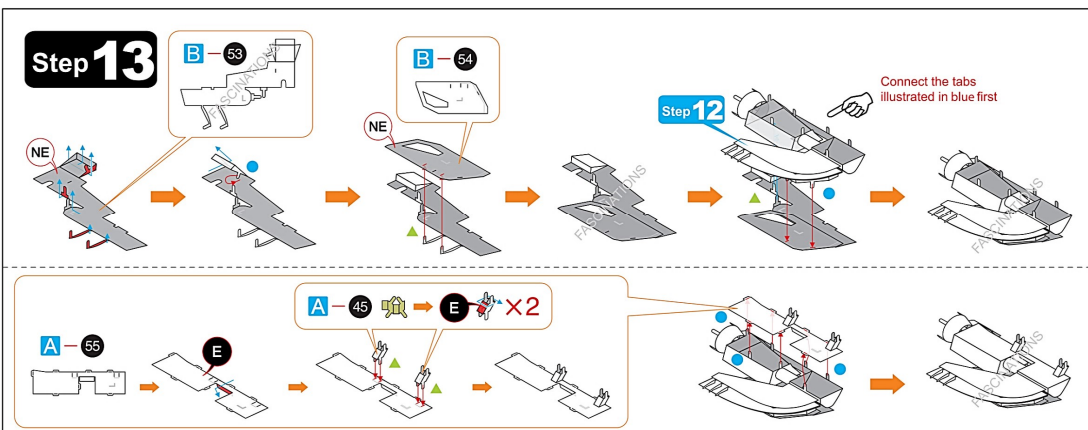
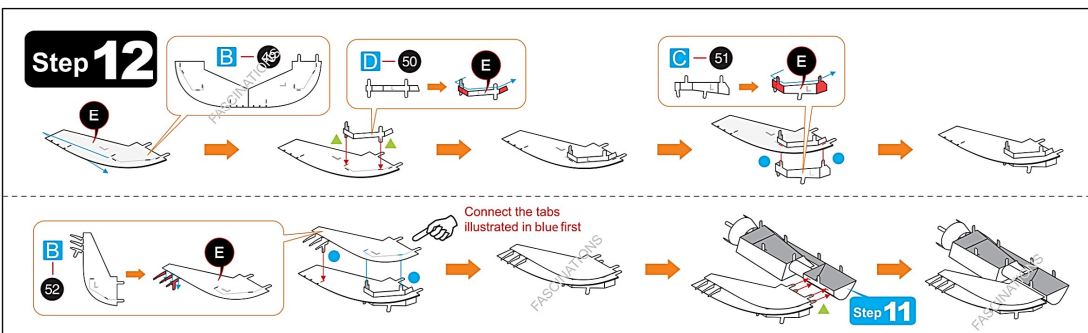
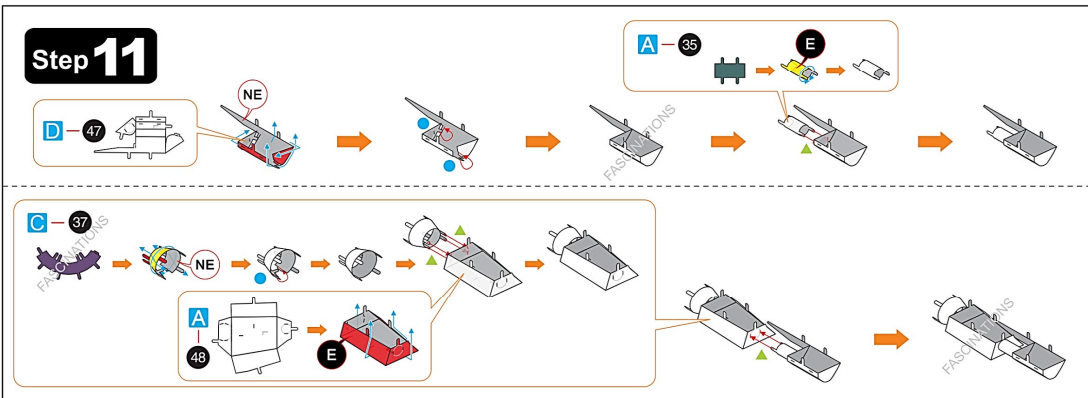
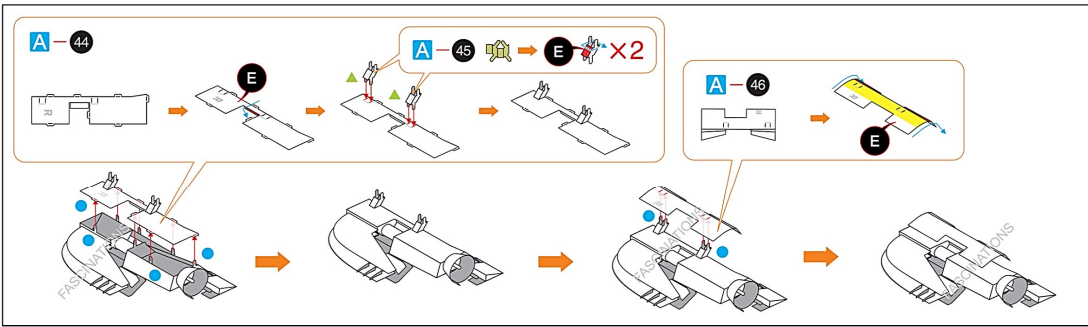

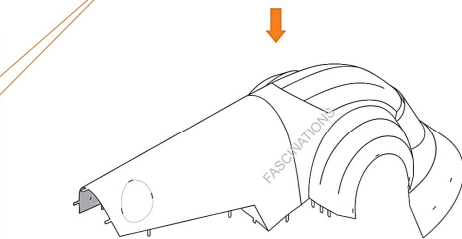
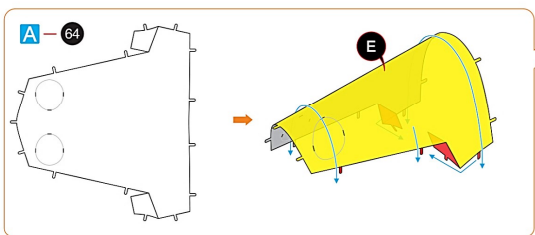
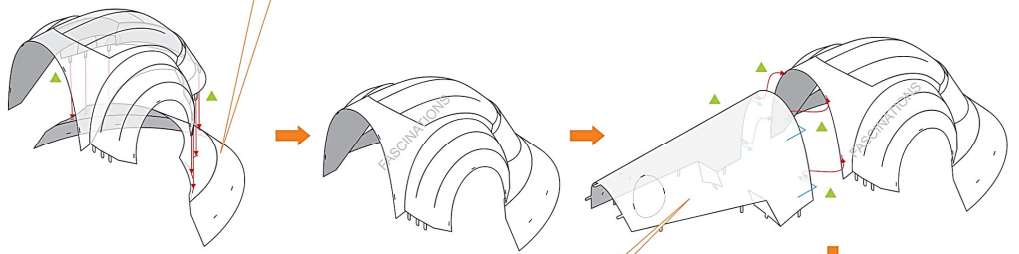
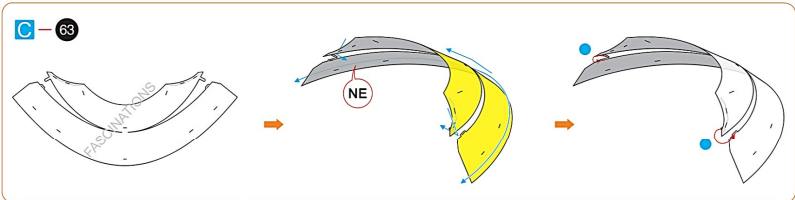

Step 16

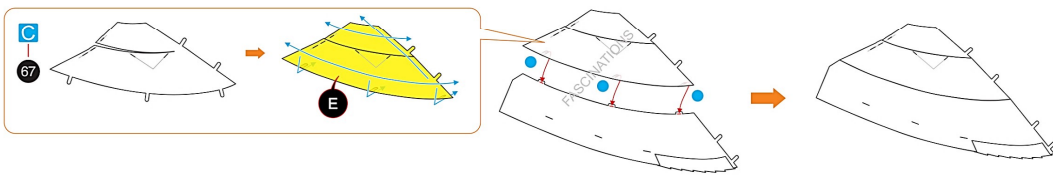
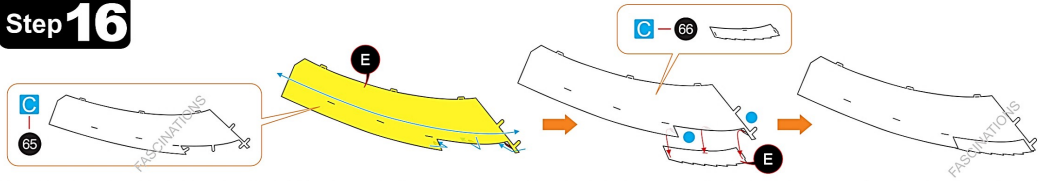

Step 17

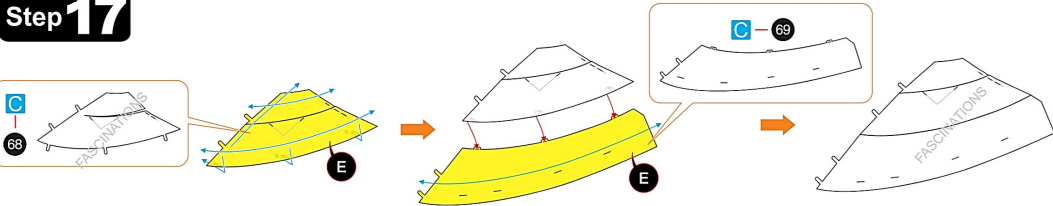

Step 18

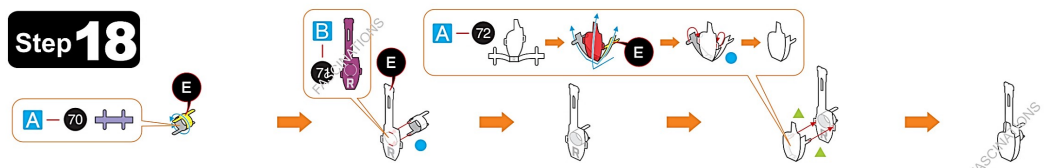

Step 19

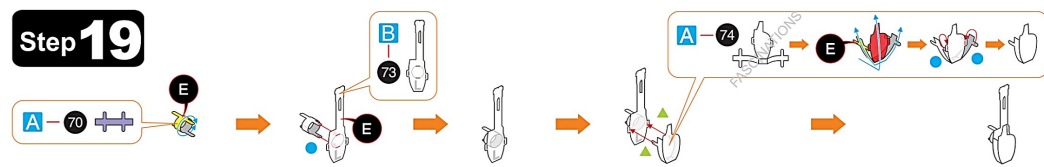

Step 20

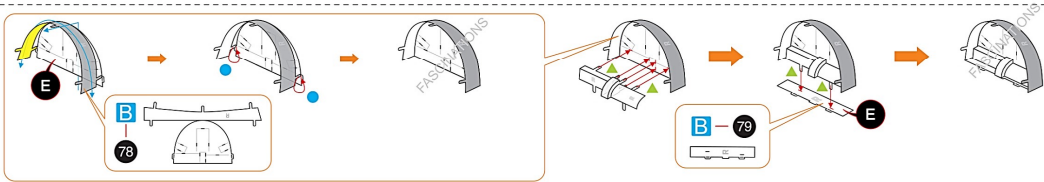
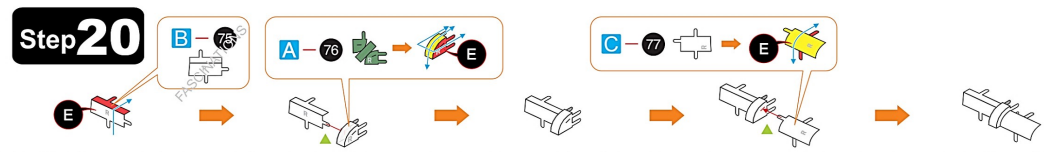

Step 21

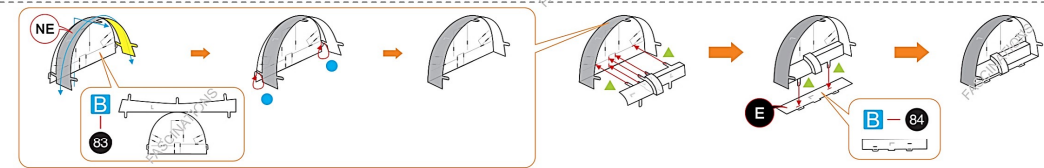
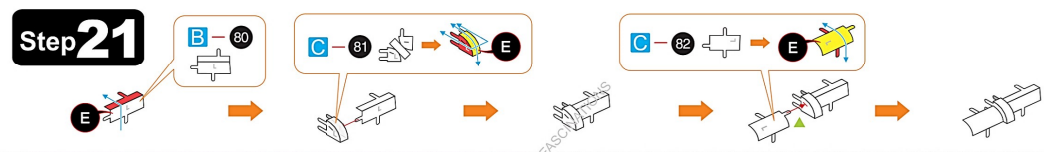

Continue on page 14 for landing option

Step 22

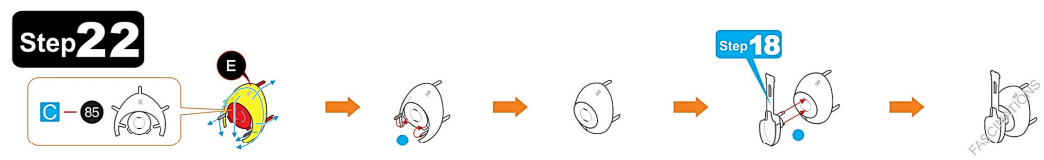

Step 23

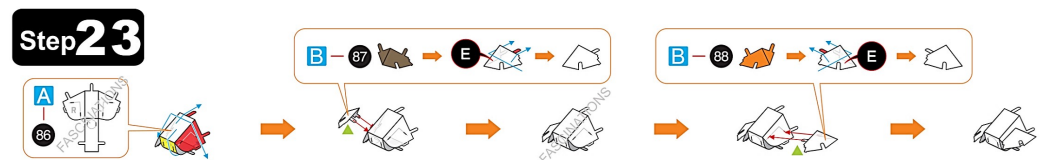

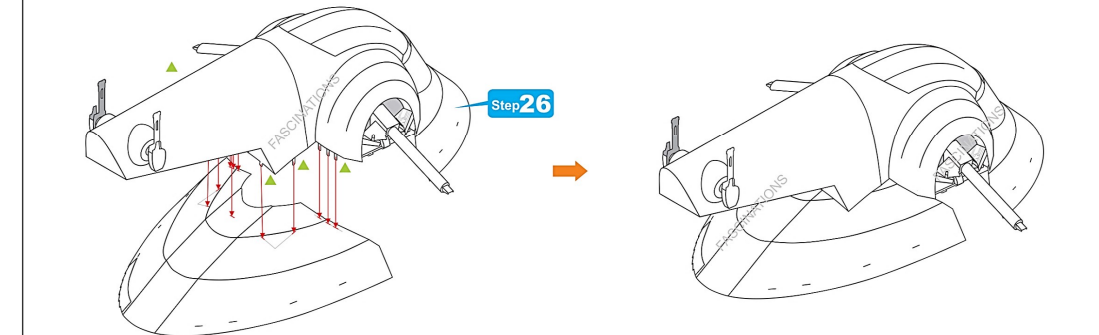
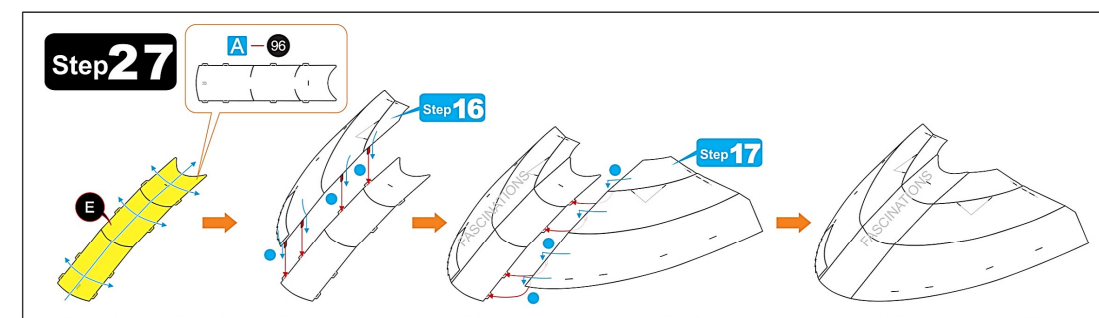
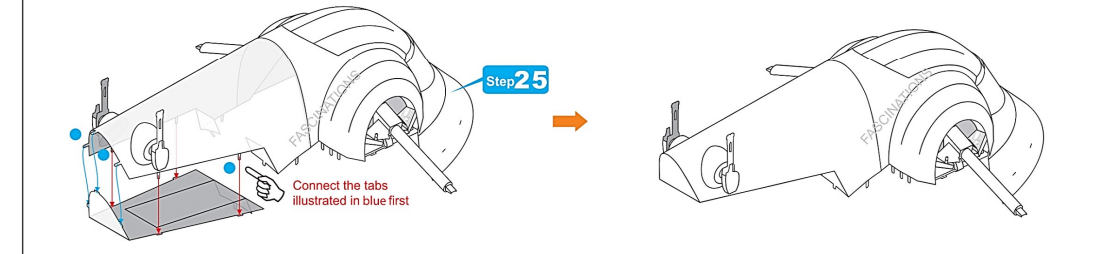
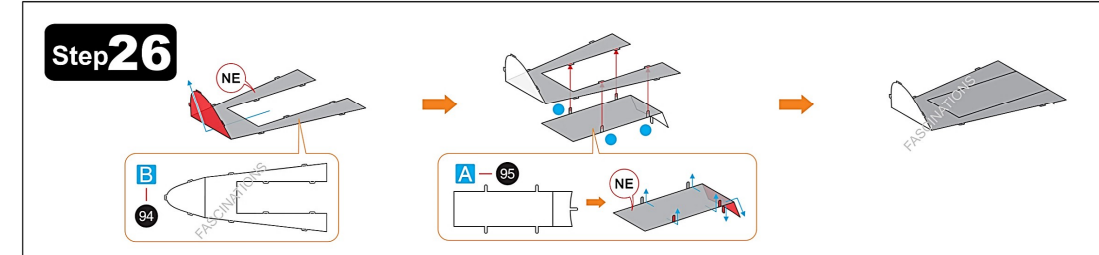
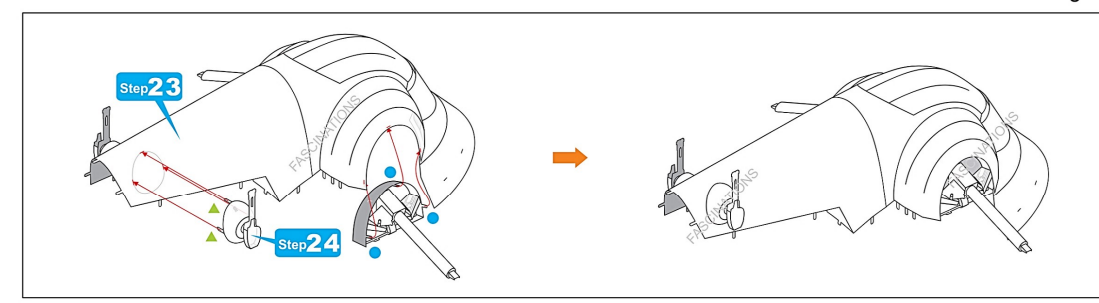
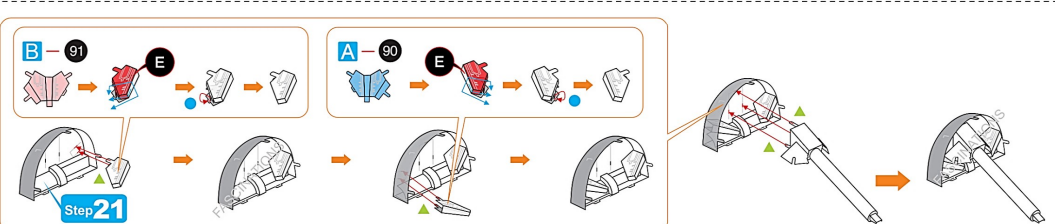
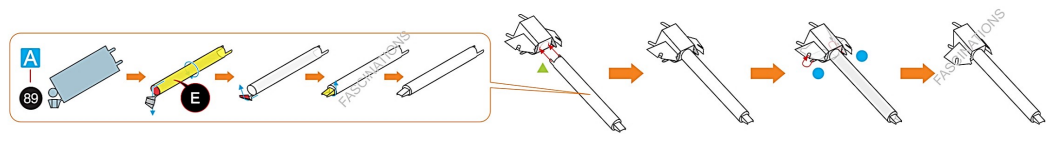
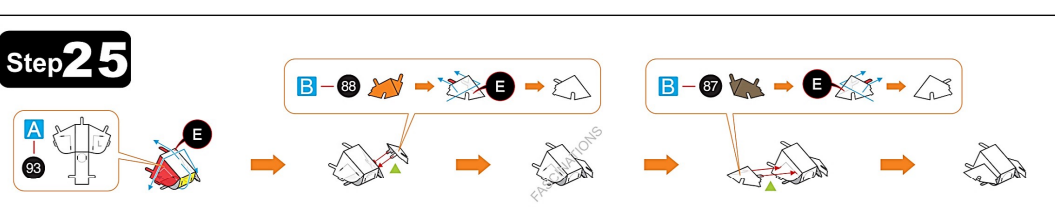
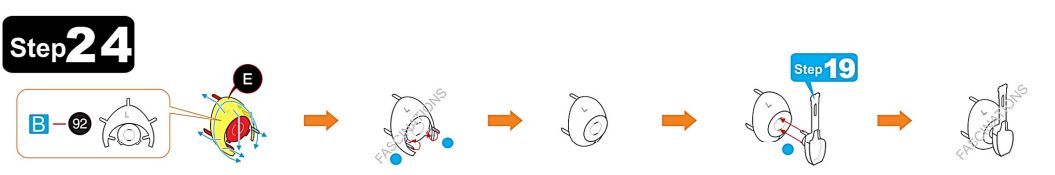
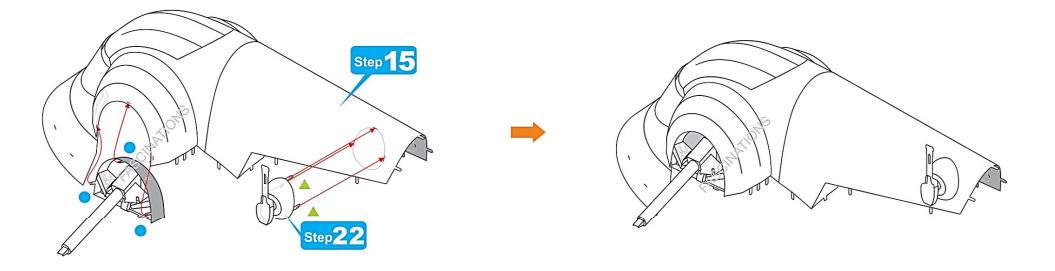
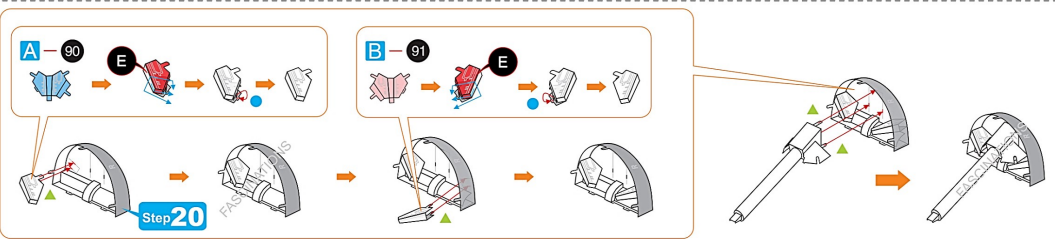
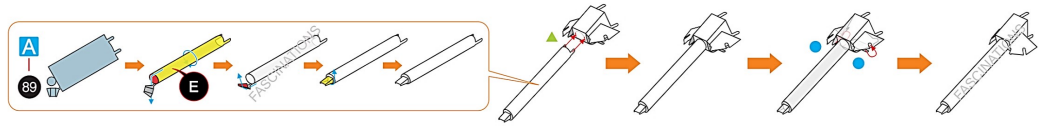

Step 28

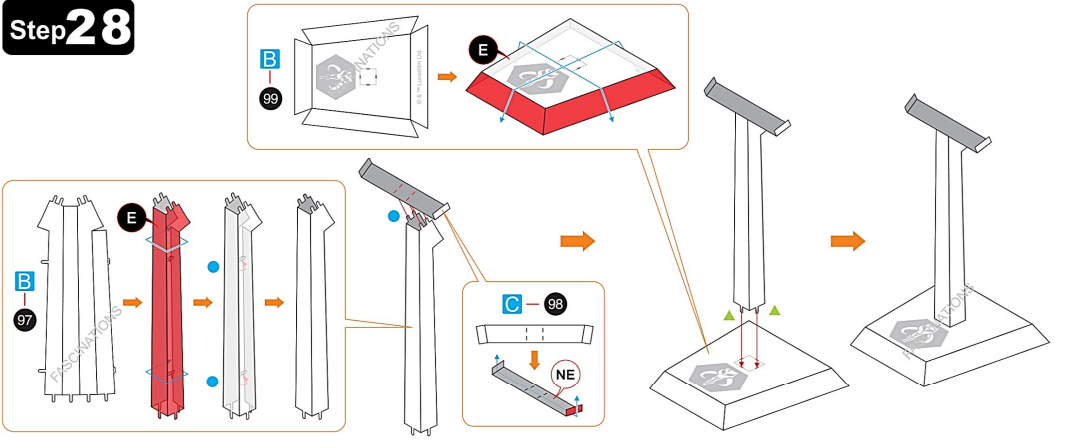

Step 29

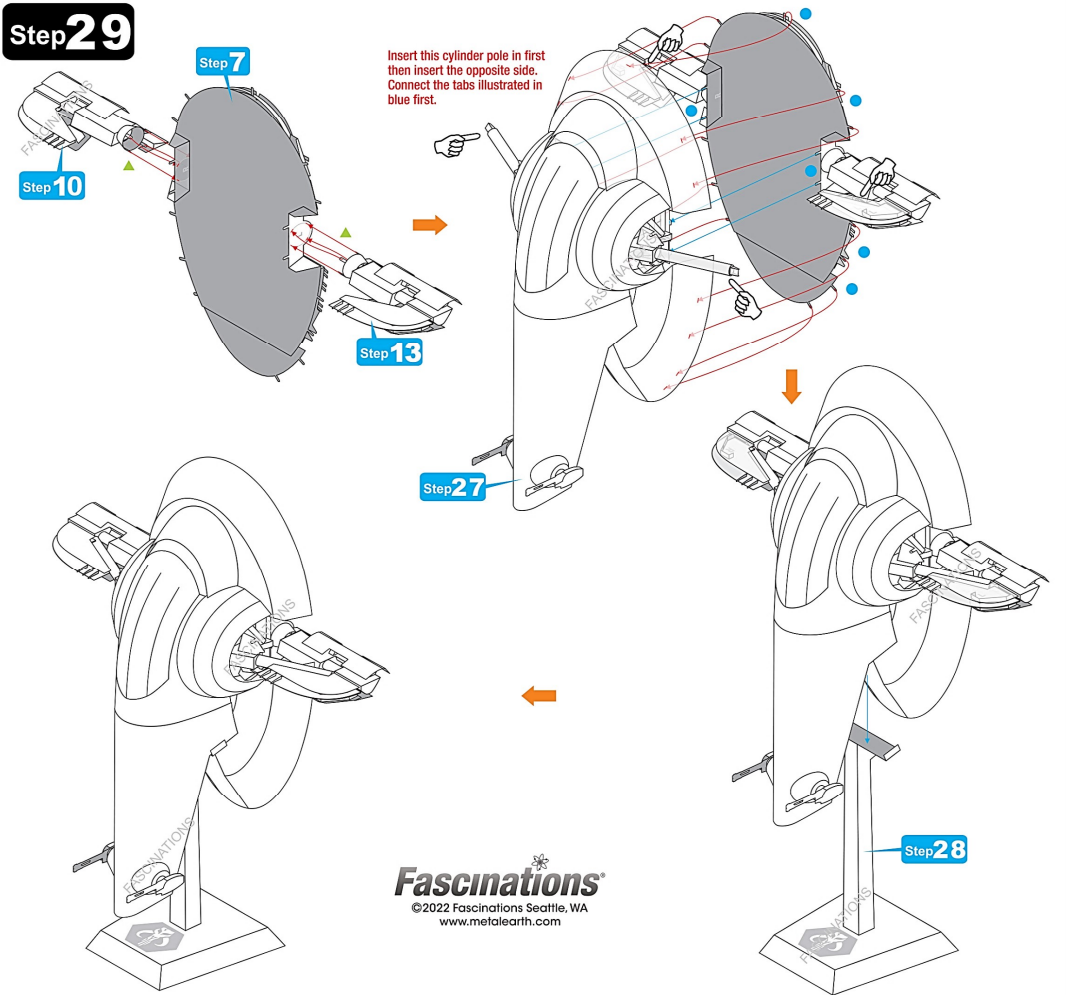

Fascinations
 ©2022 Fascinations Seattle, WA
 www.metalearth.com

Optional landing position

Follows step 21. Parts C-85 A-86 A-90 B-91 B-92 A-93 A-95 A-96 B-97 C-98 B-99 are not needed.

Step 22

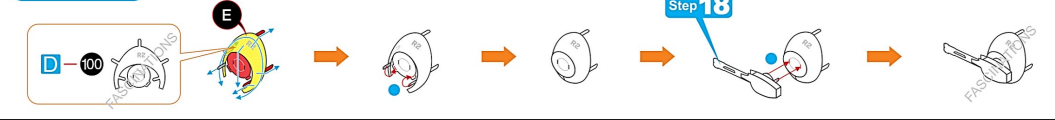

Step 23

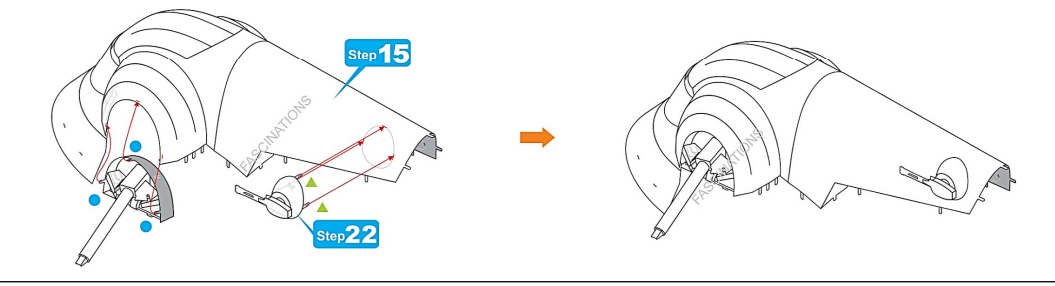
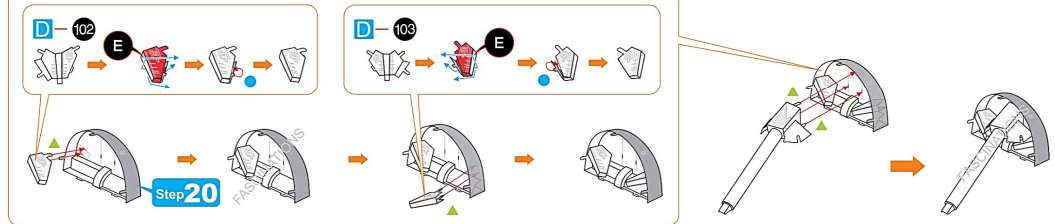
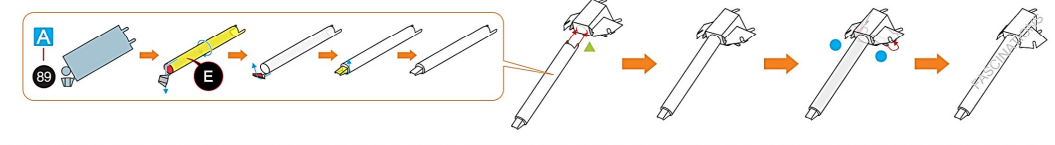
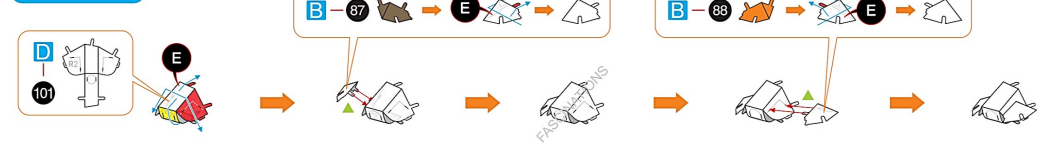

Step 24

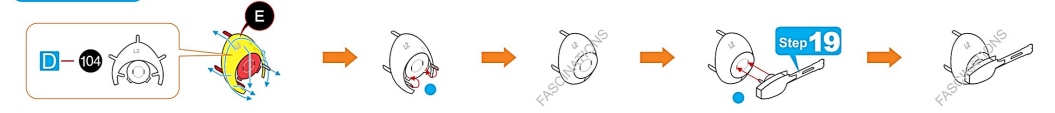

Step 25

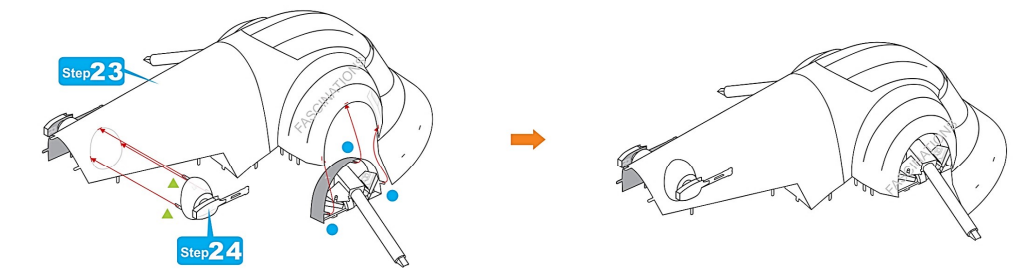
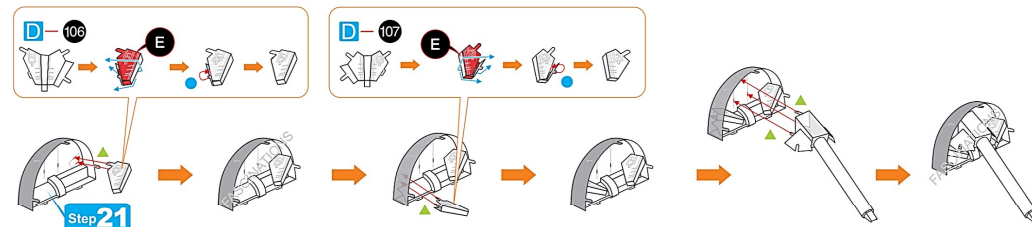
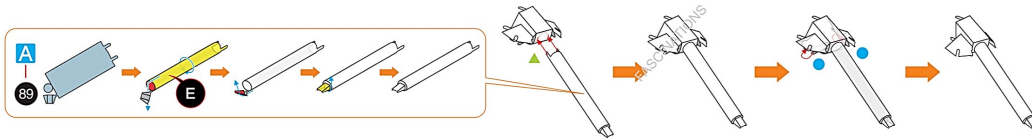
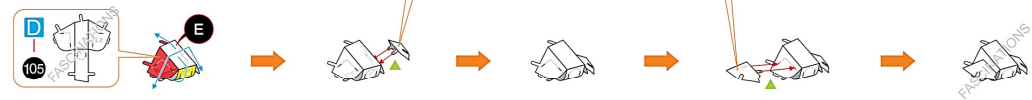

Step 26

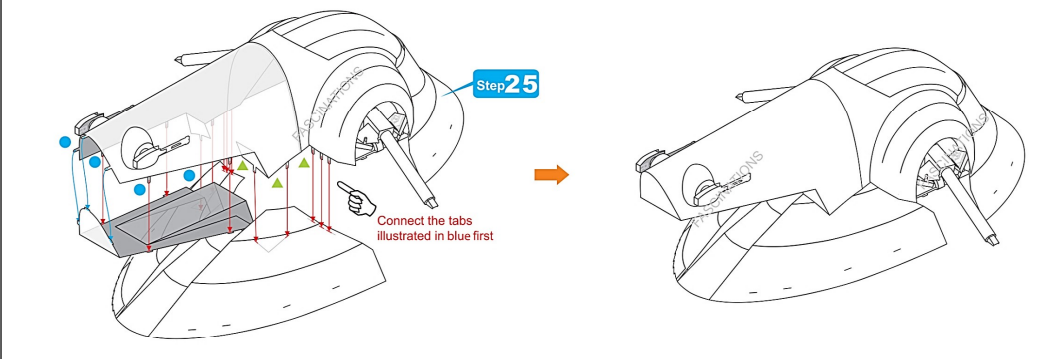
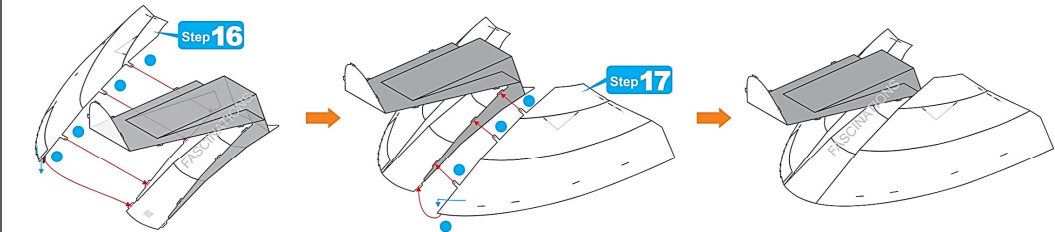
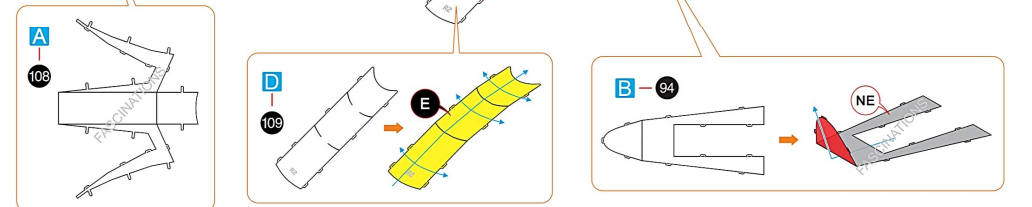
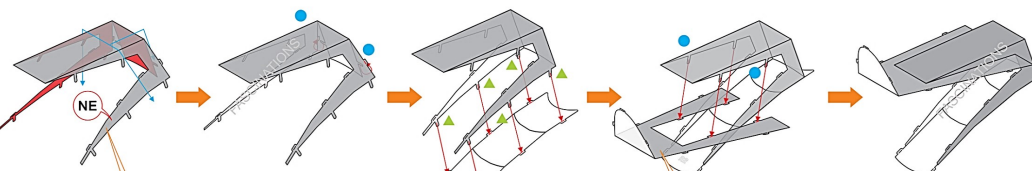

Step 27

