

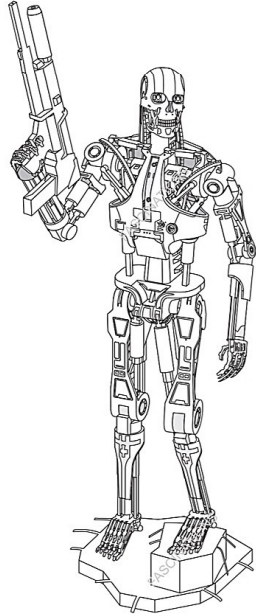

It is highly recommended that you visit www.metalearth.com/360/icx141 to see the completed model before assembling your own

THE TERMINATOR™

ICX141 T-800 ENDOSKELETON



TO CREATE THE BEST CONNECTIONS

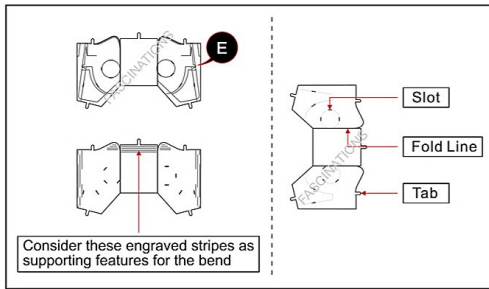

Legends:

- Engraved/Color side
- Non-engraved/Silver side
- Attention point
- Insert tab and bend 90 degrees
- Insert tab and twist 90 degrees

Assembly tip:

If needed, slightly twist tabs to hold parts together then untwist and bend them down for a nice finish

Recommended tools:

-Wire cutters: helpful for taking parts from the metal sheets.



-Tweezers or needle nose pliers: helpful for folding parts, bending and twisting tabs.

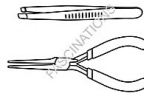

METAL SHEETS

A

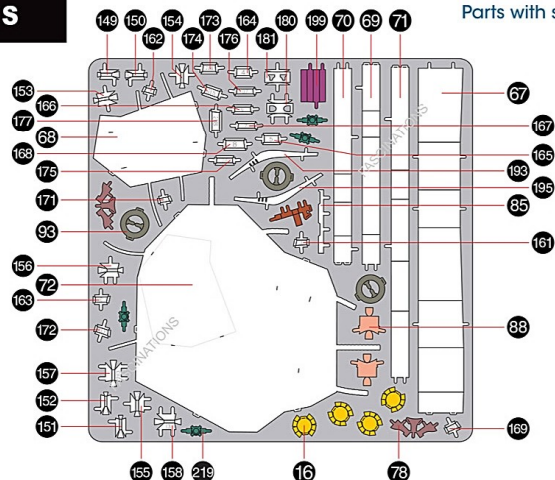

In order to avoid possible injury from sharp edges, please carefully discard the metal sheets after parts have been removed



Go to www.metalearth.com/360/icx141 to see the zoomable PDF version of this instruction sheet

B

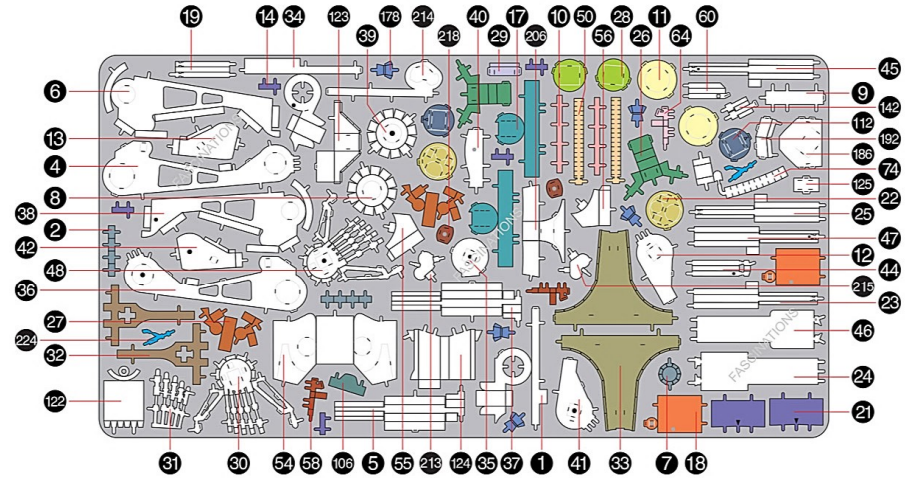

C

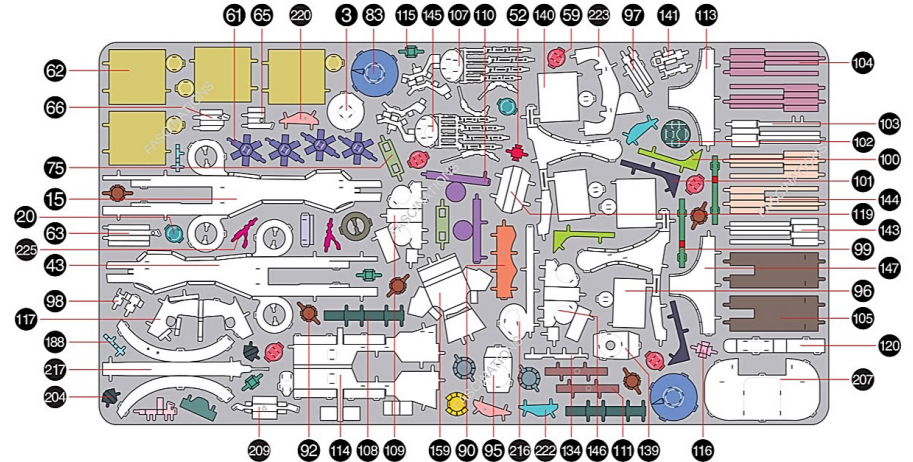

D

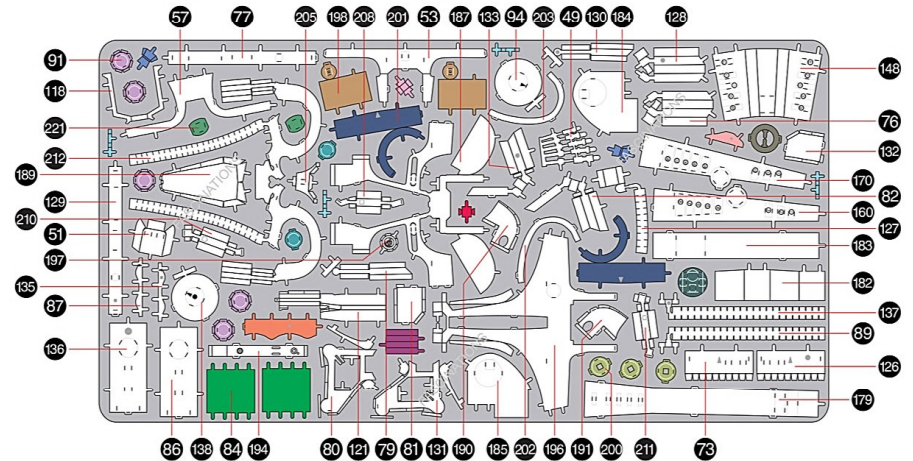

ASSEMBLY STEPS

Step 1

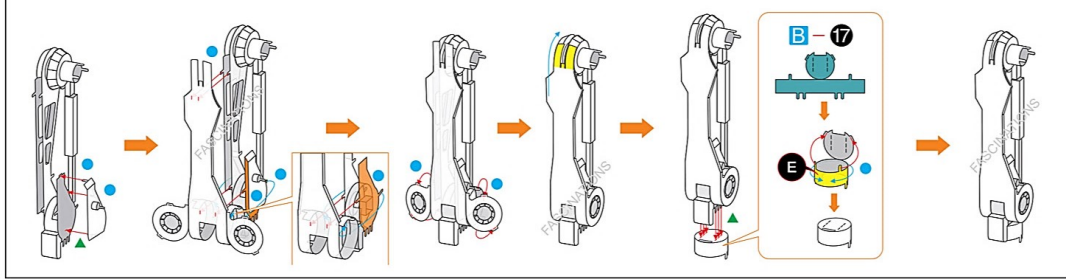
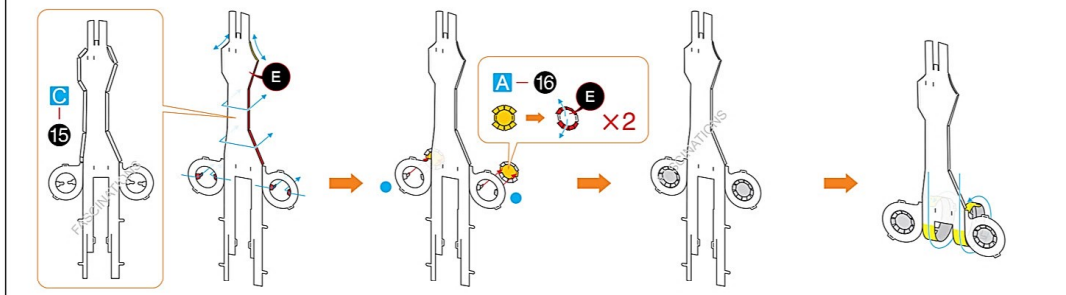
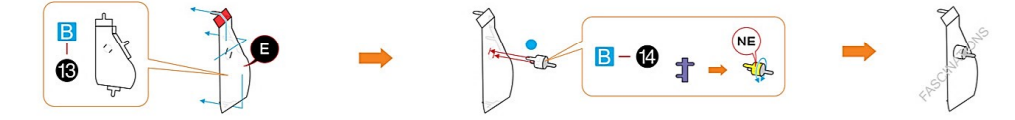
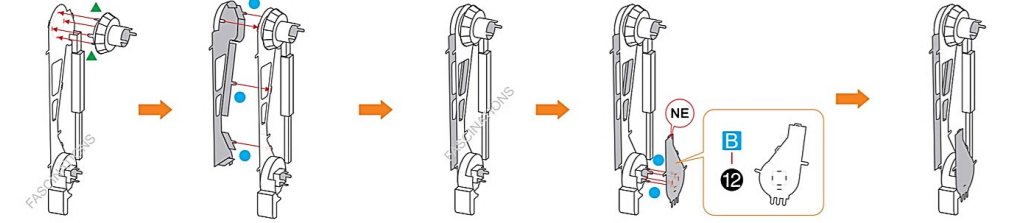
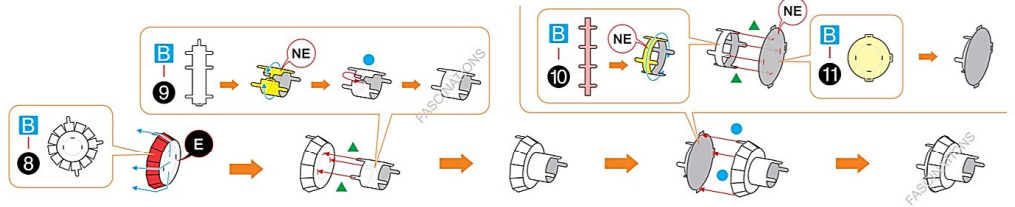
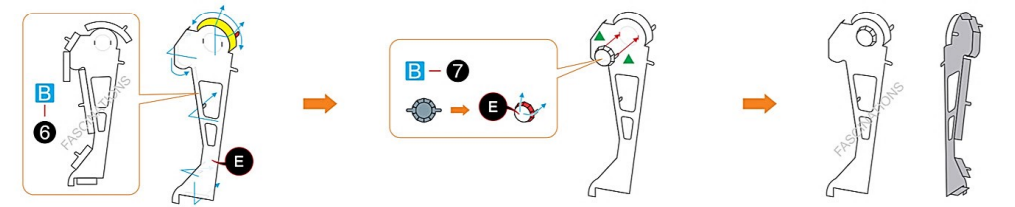
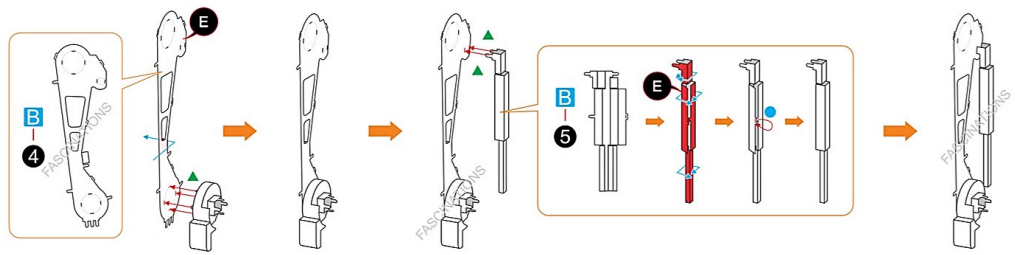
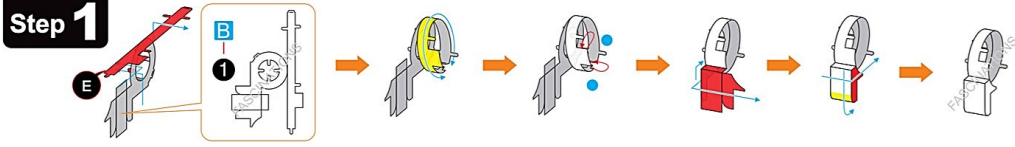

Step 2

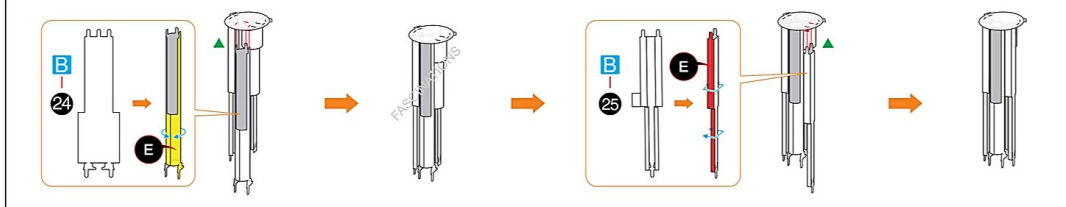
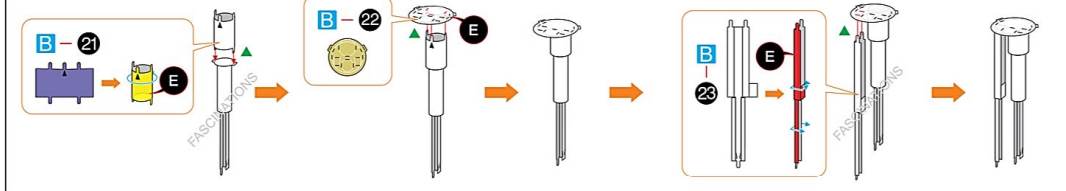
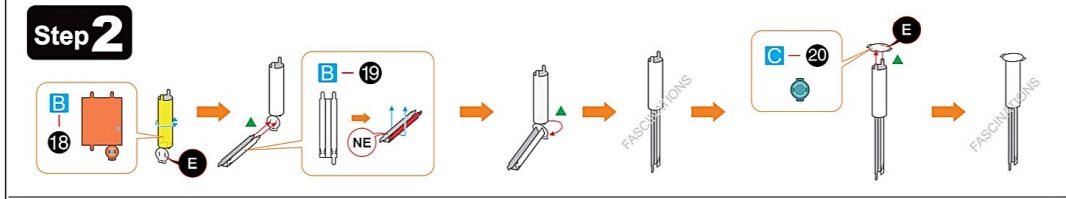

Step 3

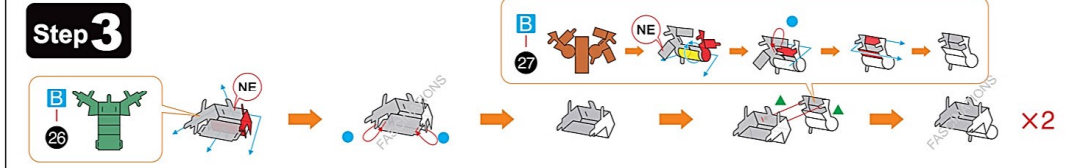

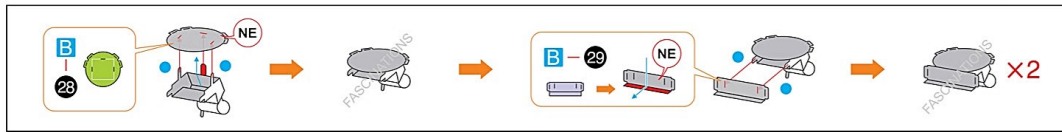

Step 4

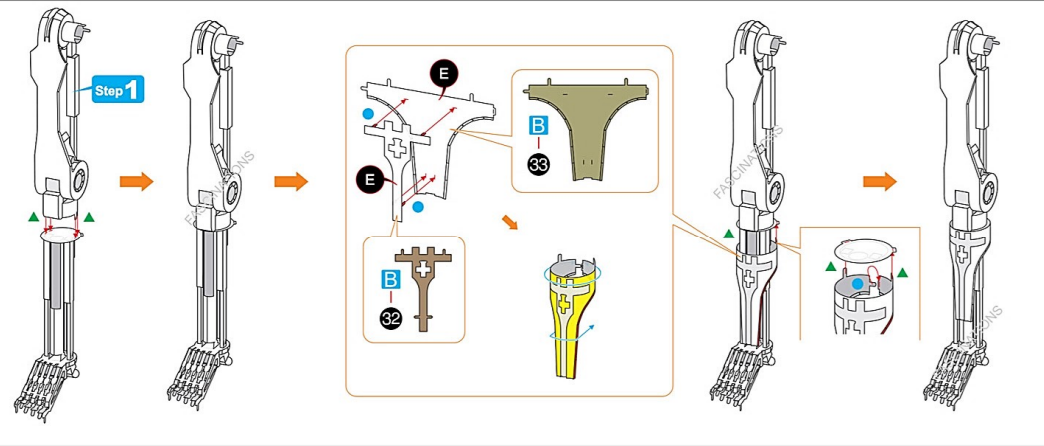
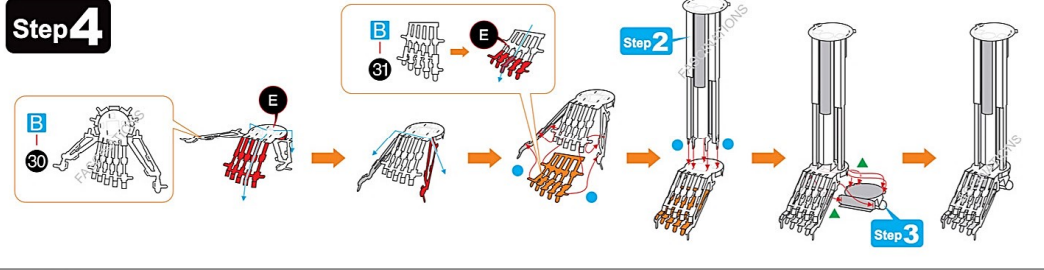

Step 5

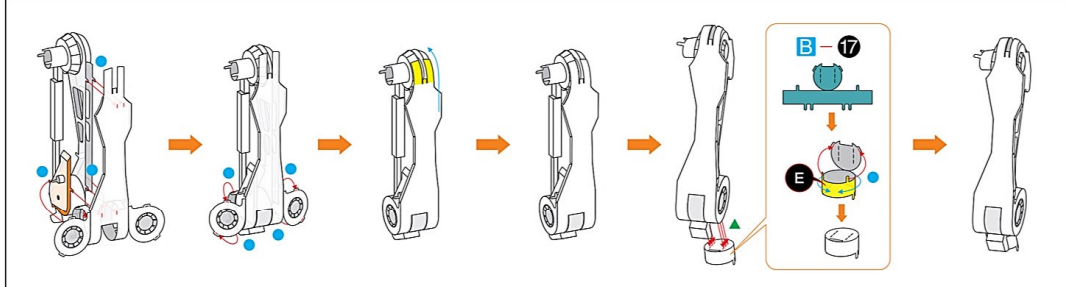
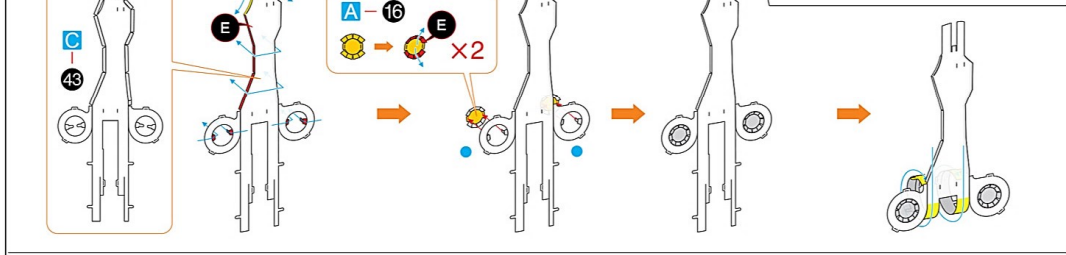
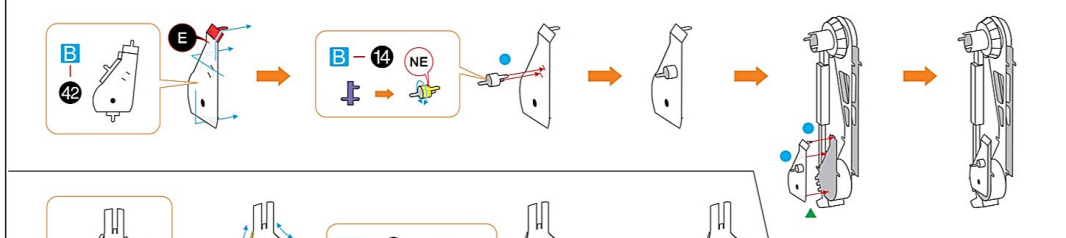
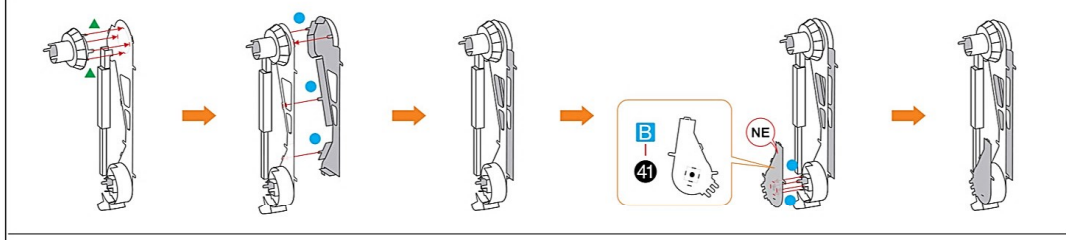
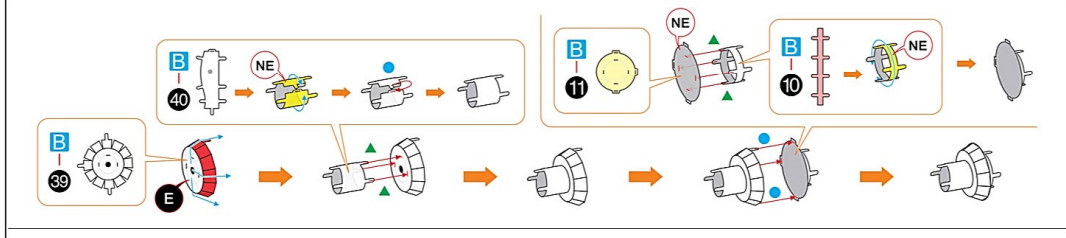
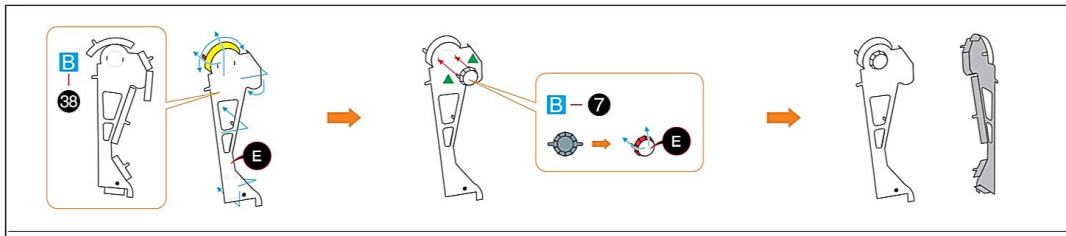
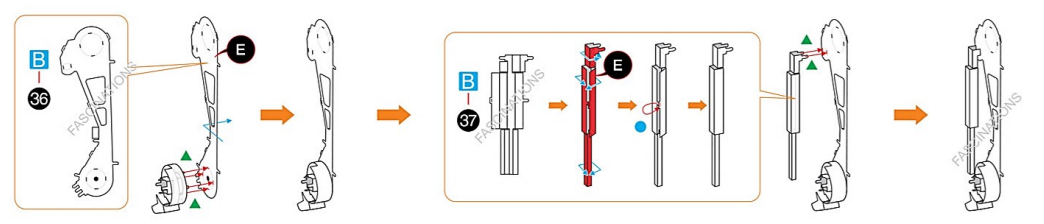
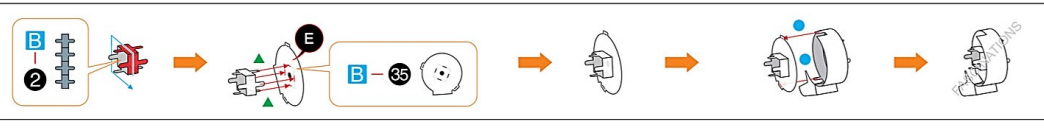
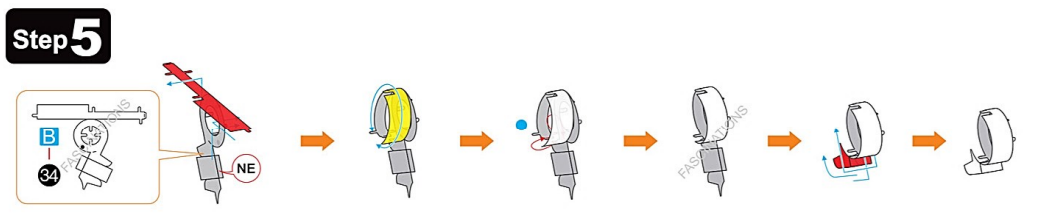

Step 6

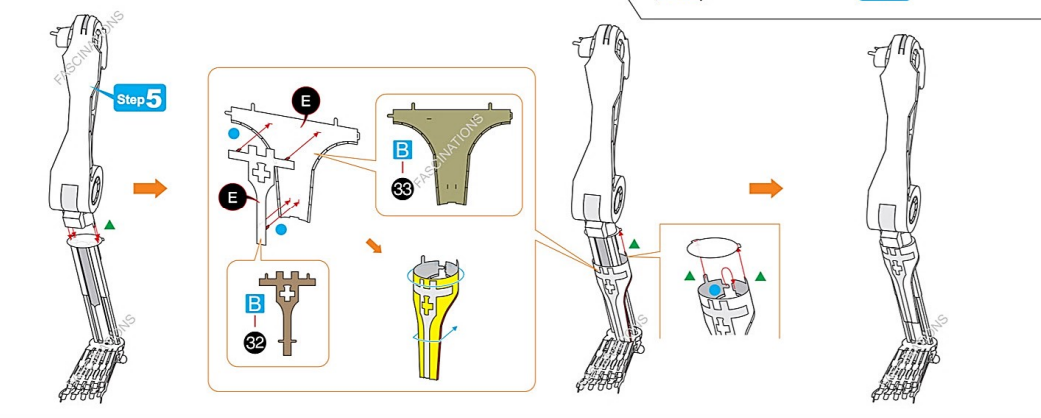
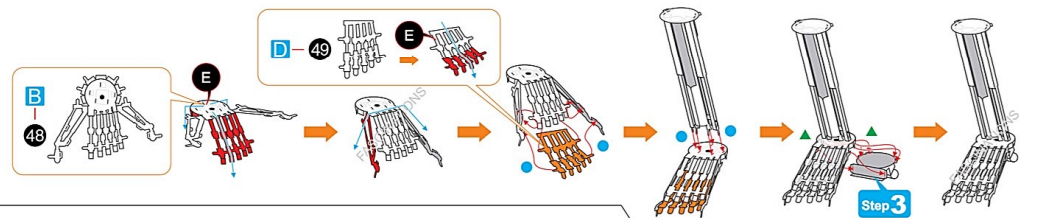
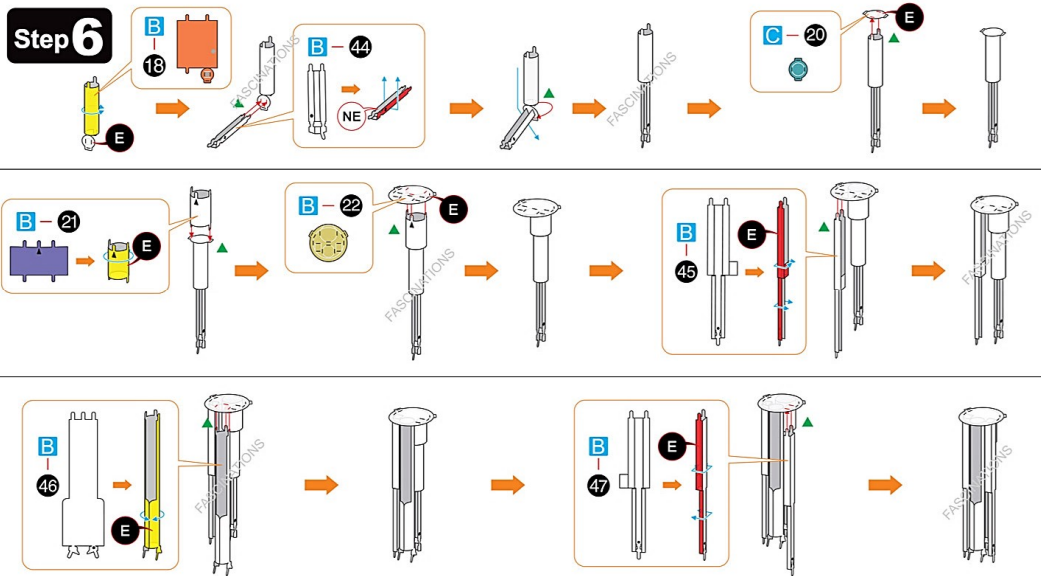

Step 7

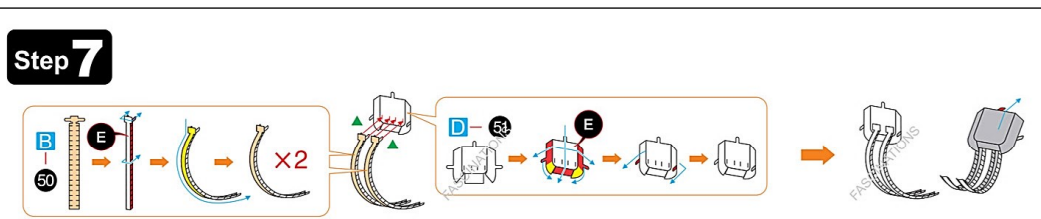

Step 8

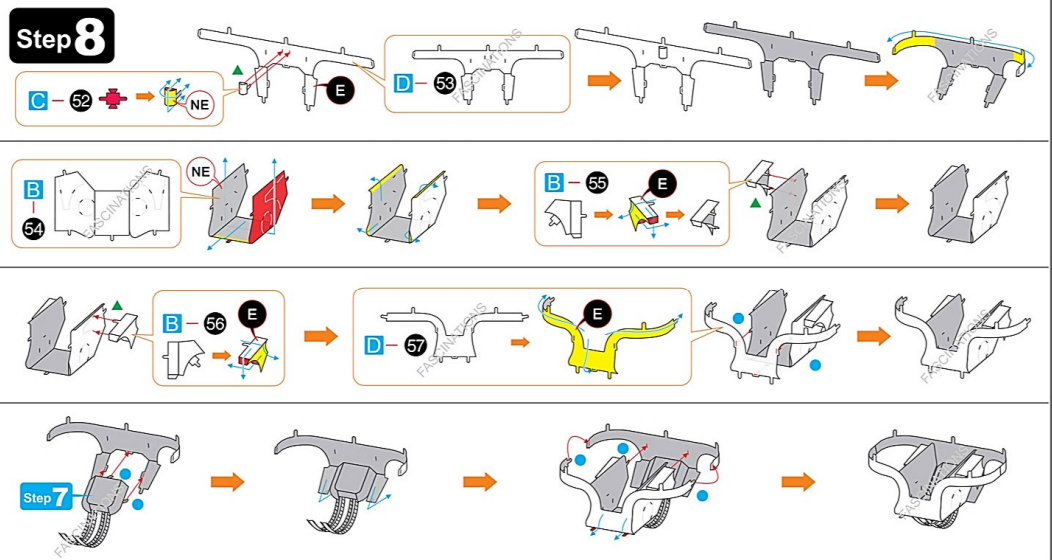

Step 9

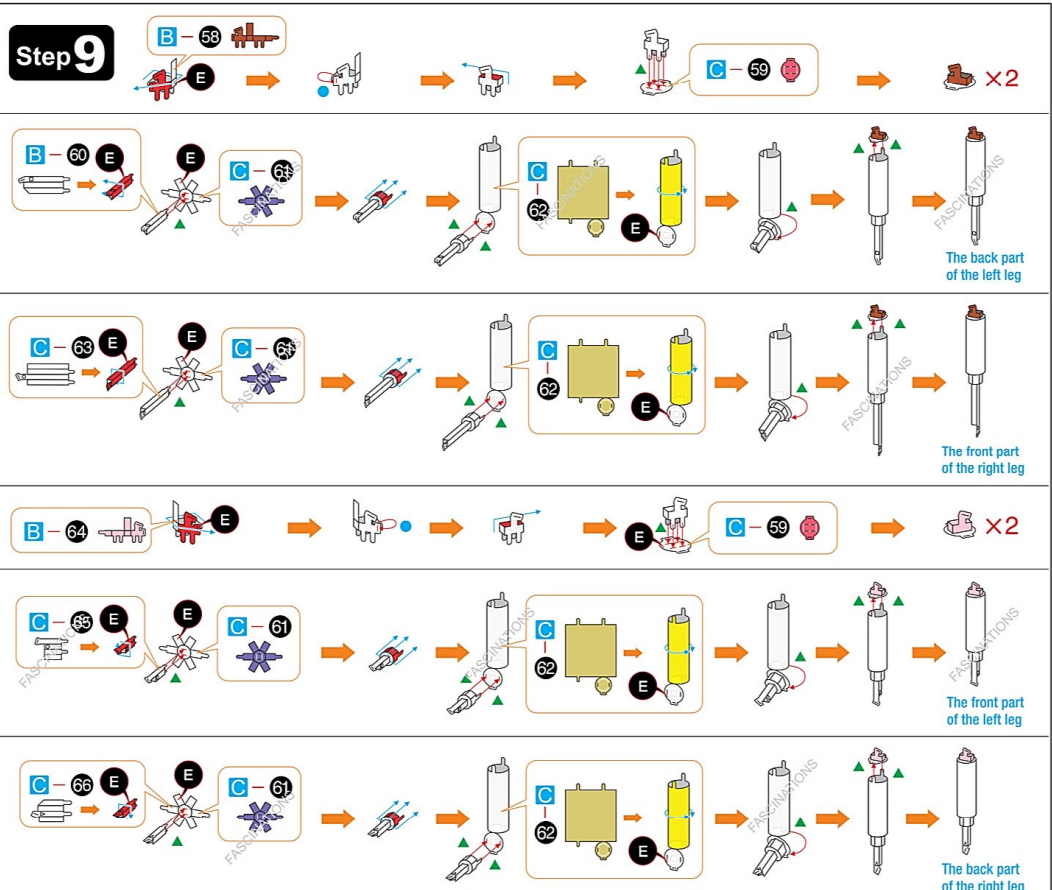

Step 10

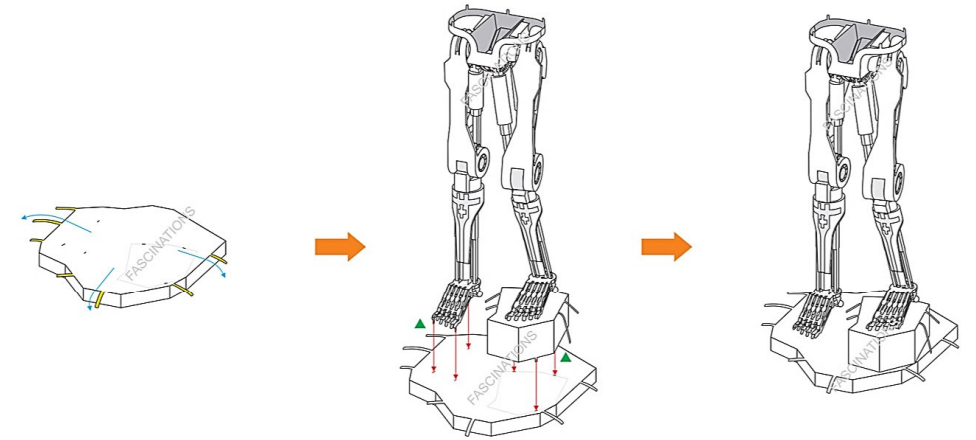
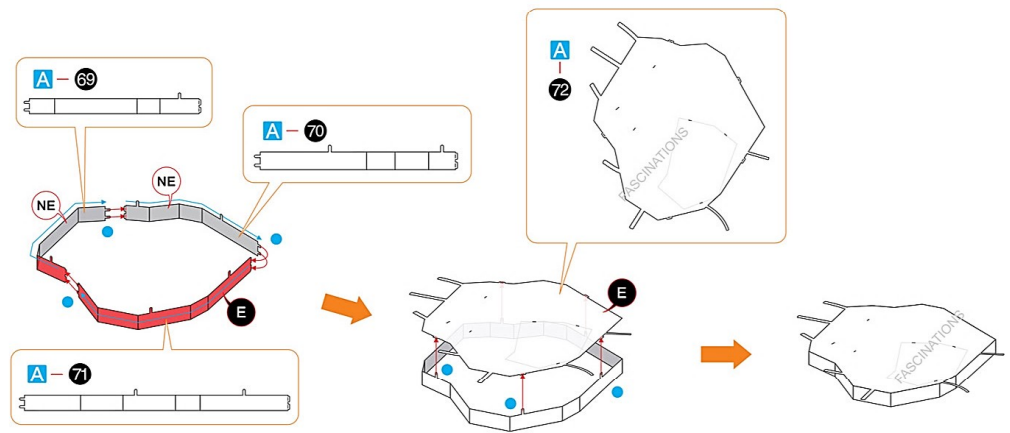
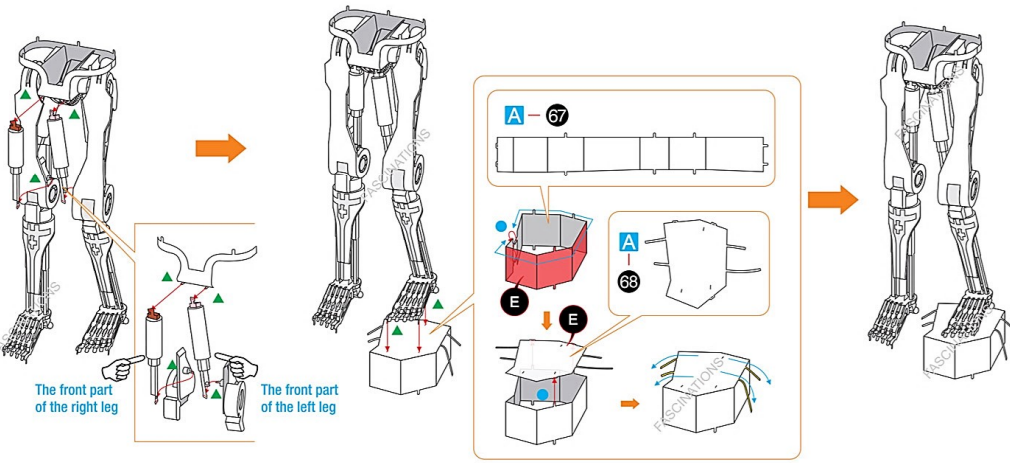
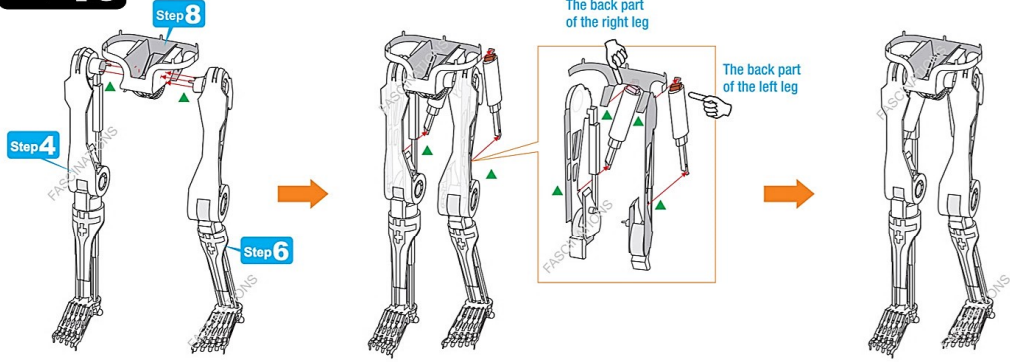

Step 11

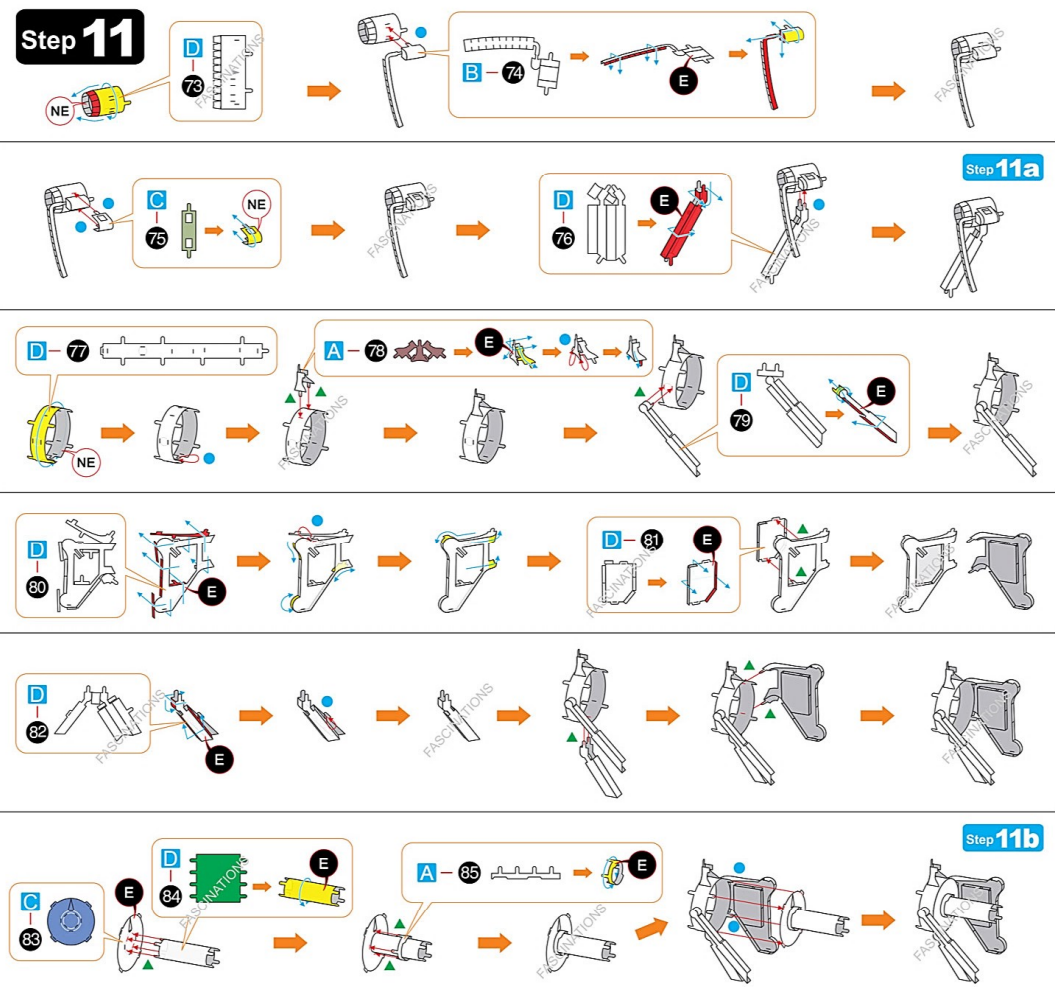

Step 12

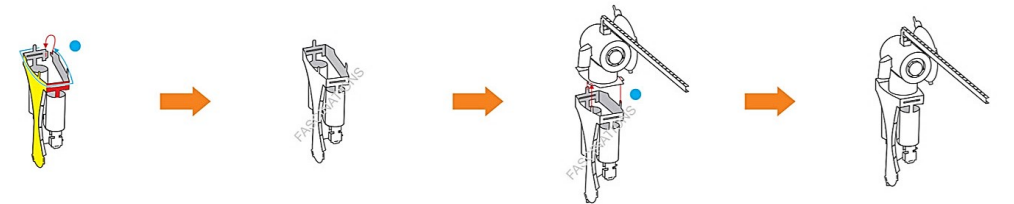
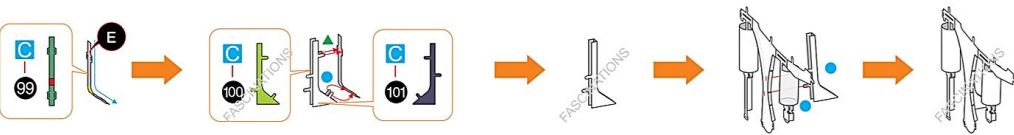
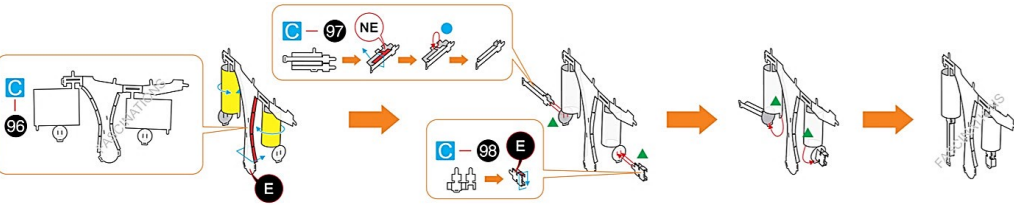
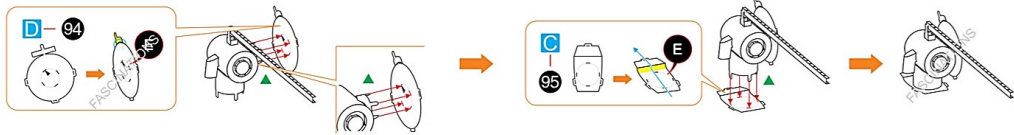
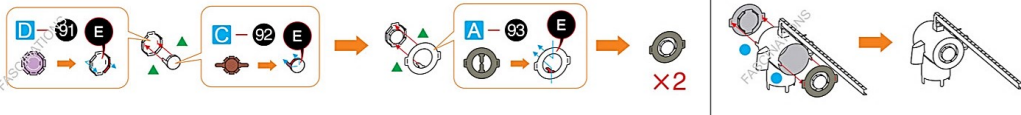
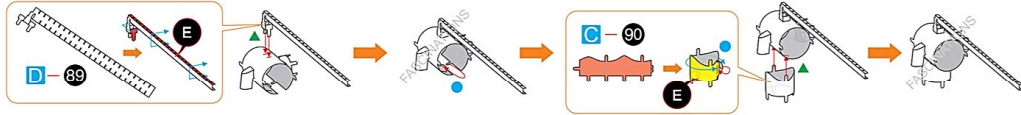
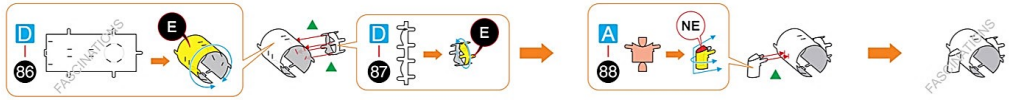

Step 13

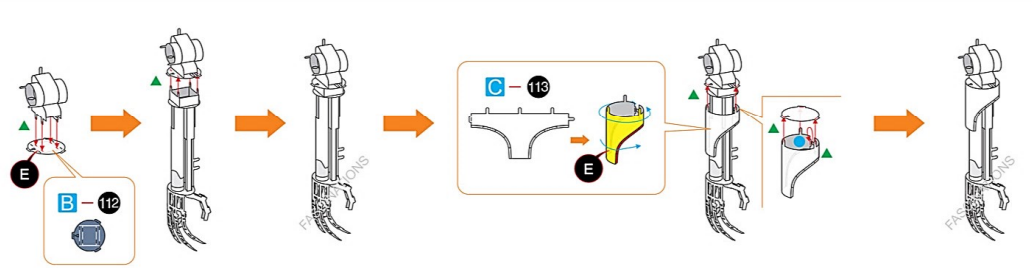
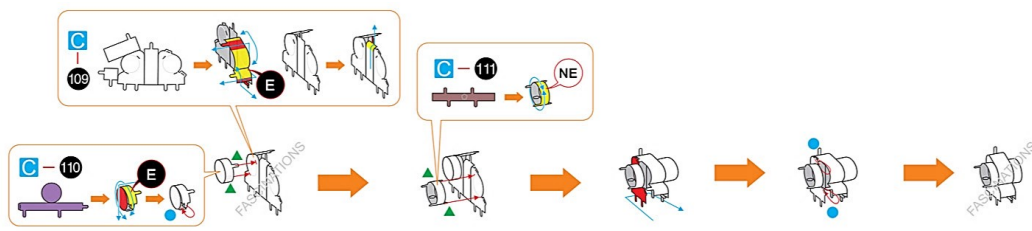
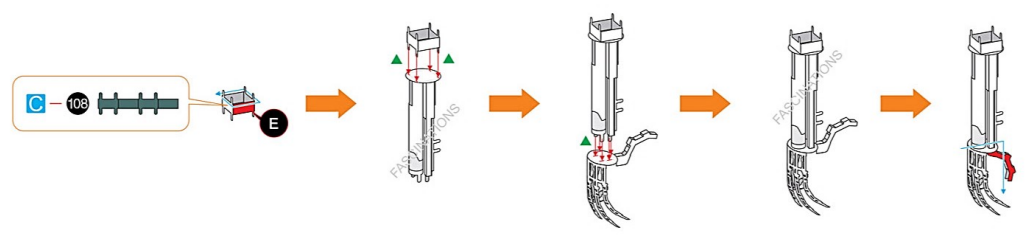
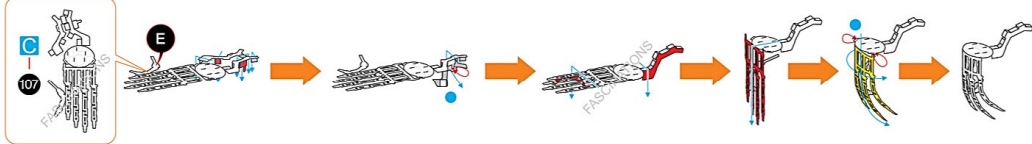
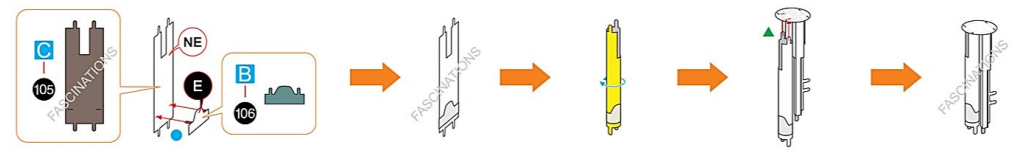
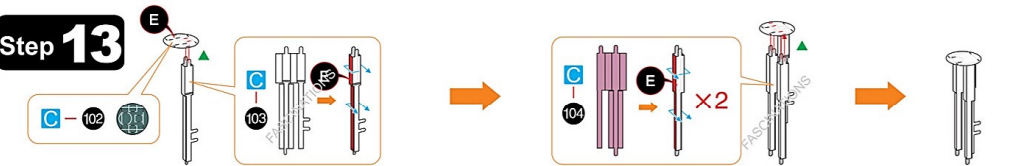

Step 14

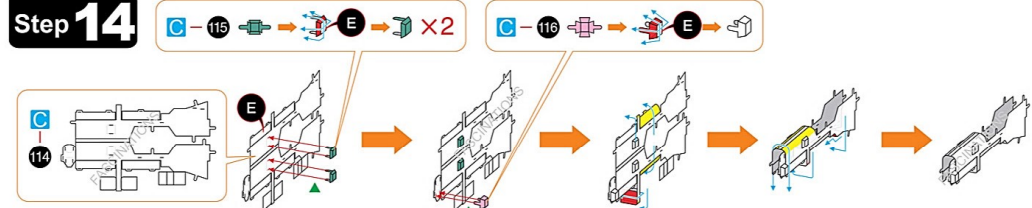

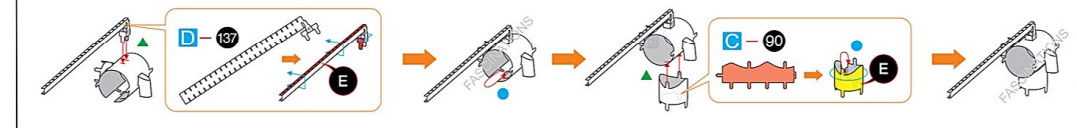
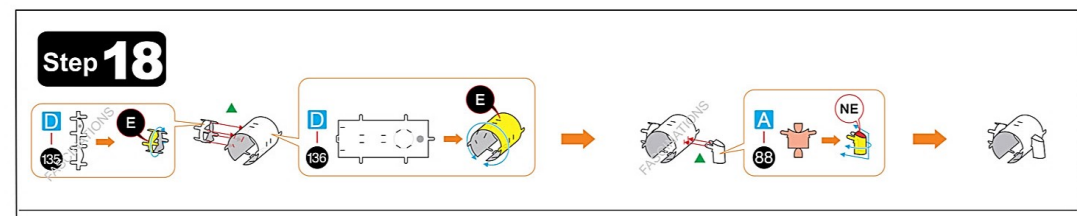
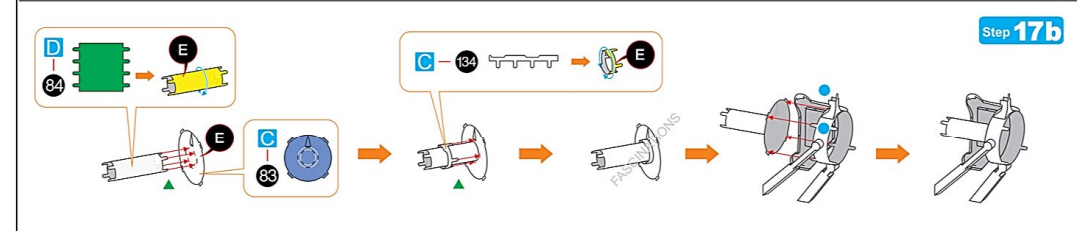
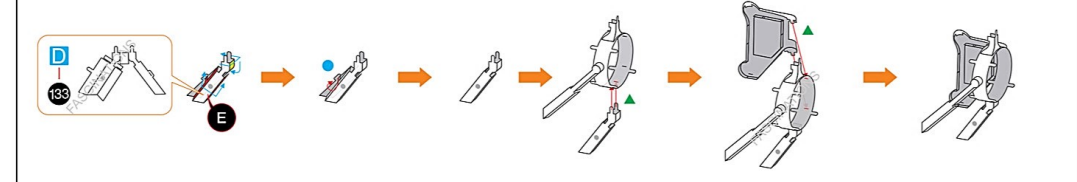
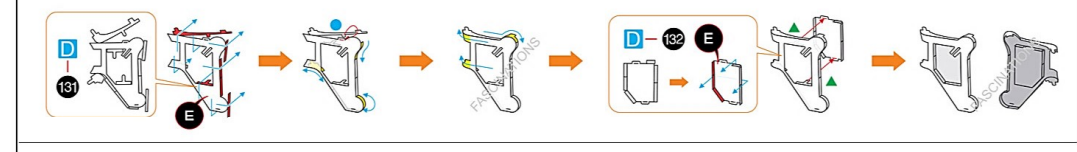
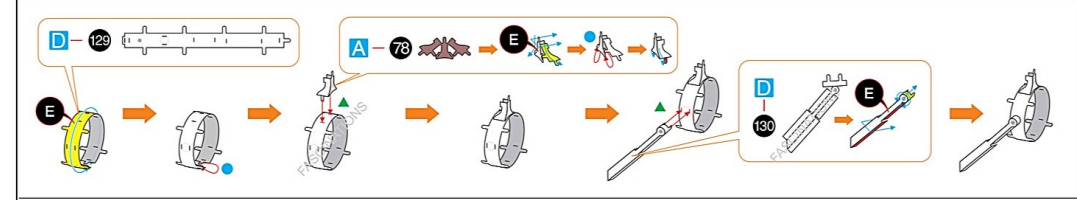
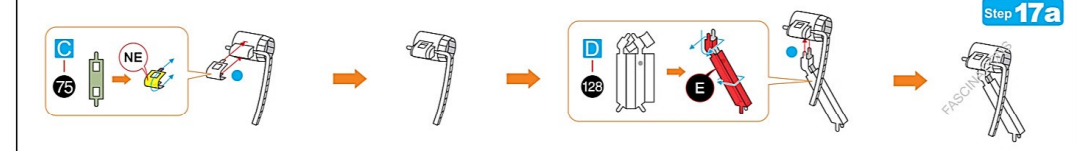
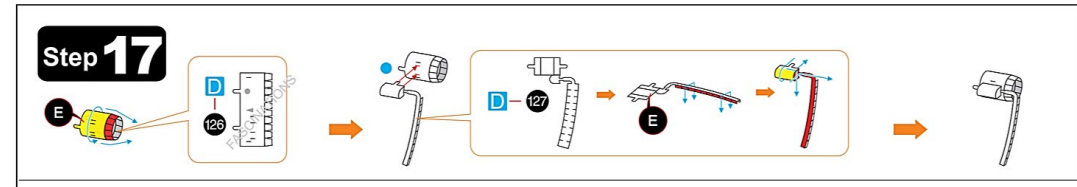
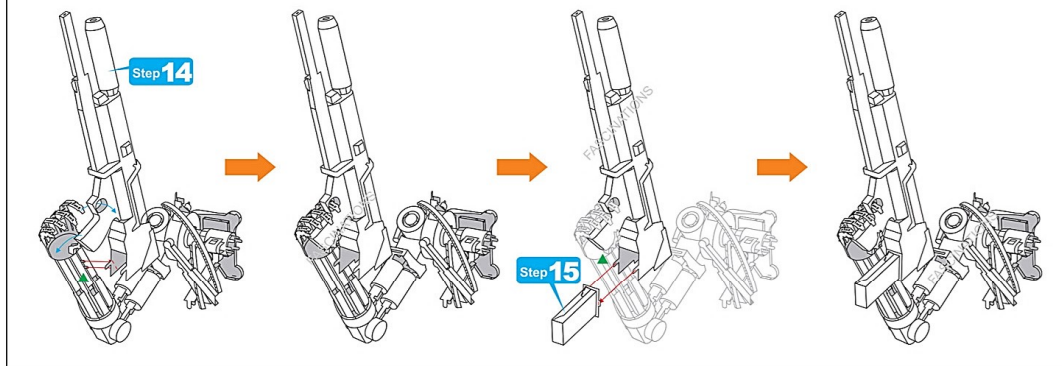
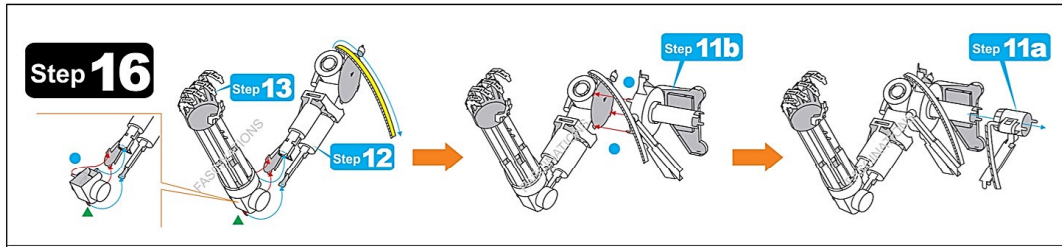
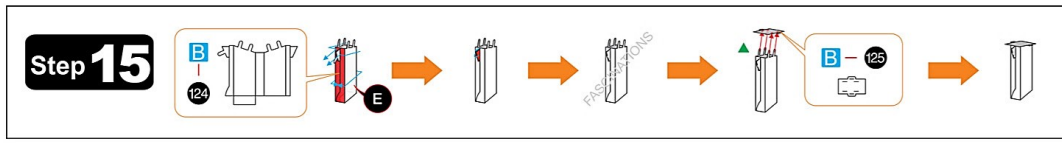
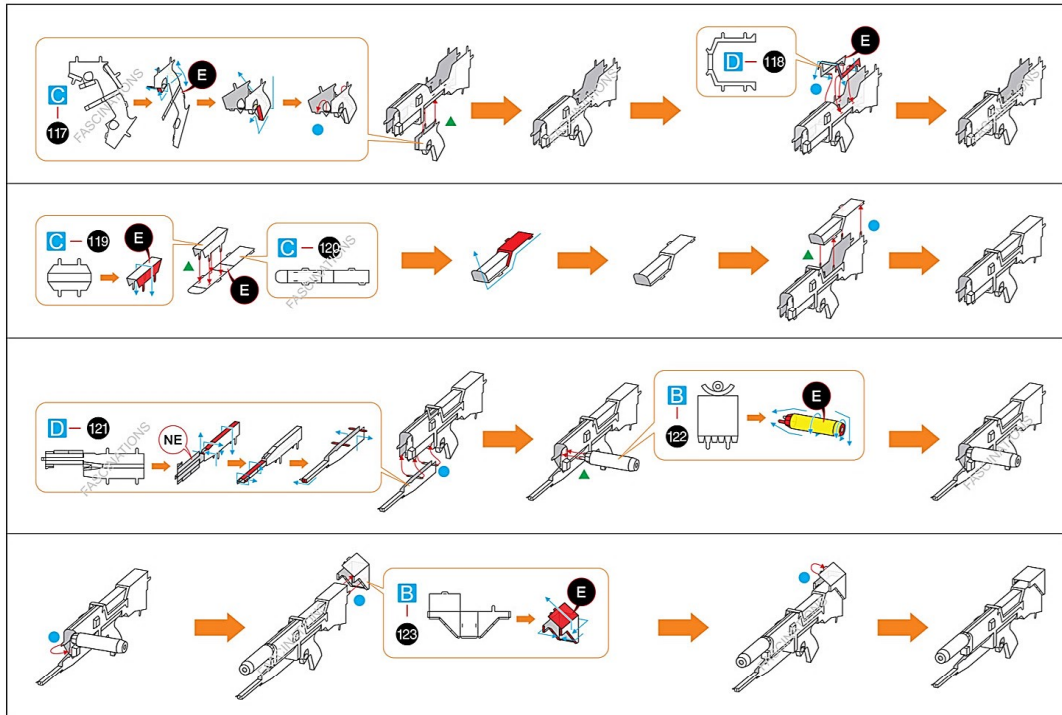

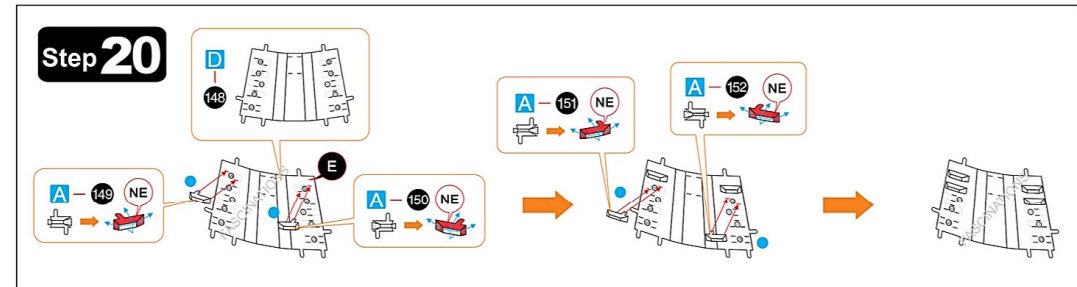
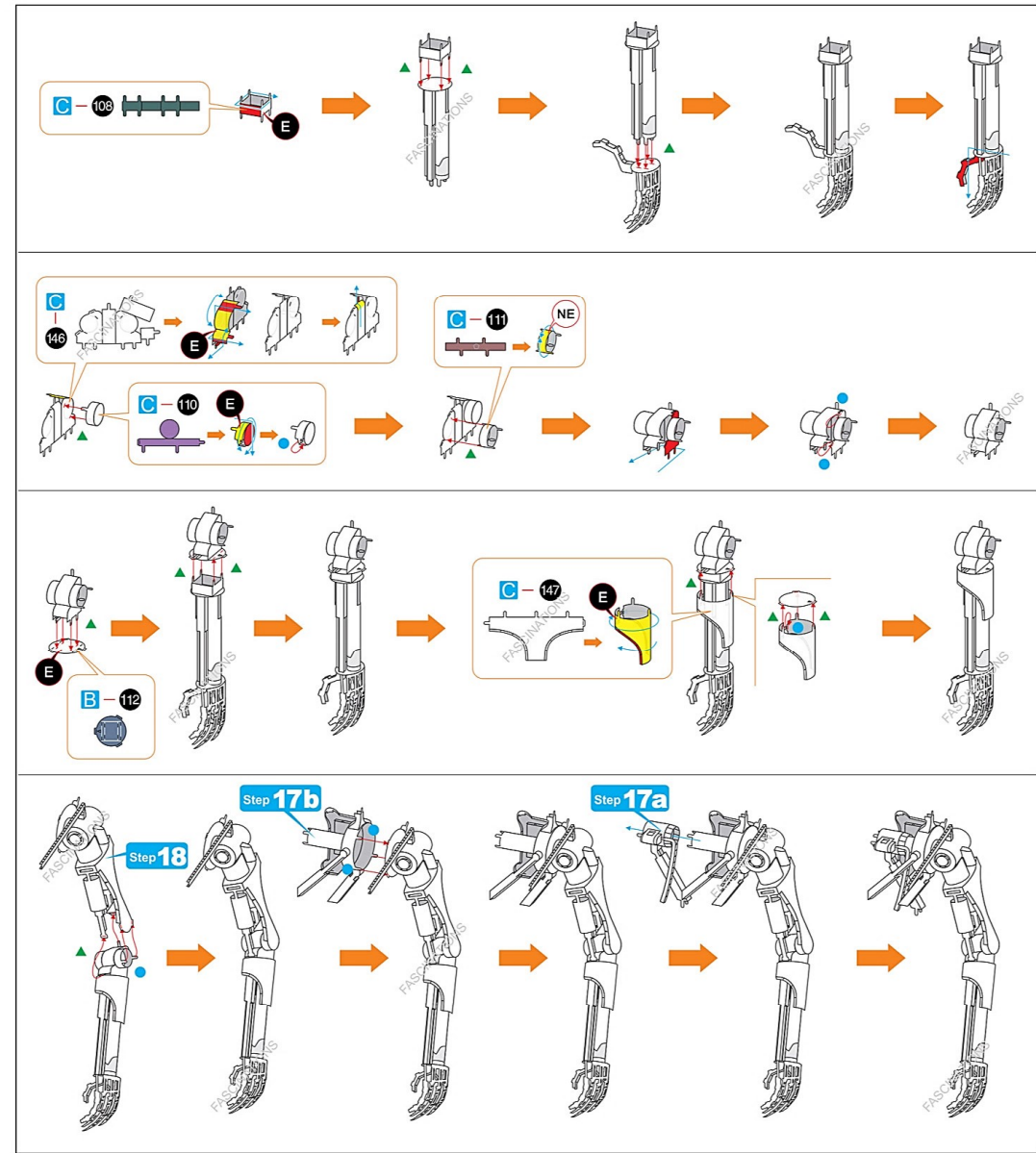
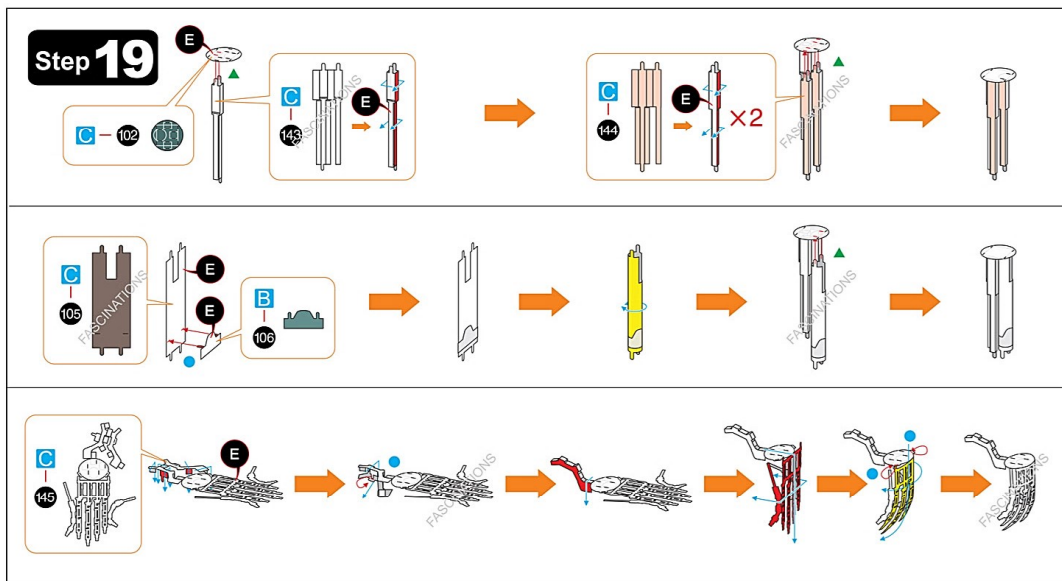
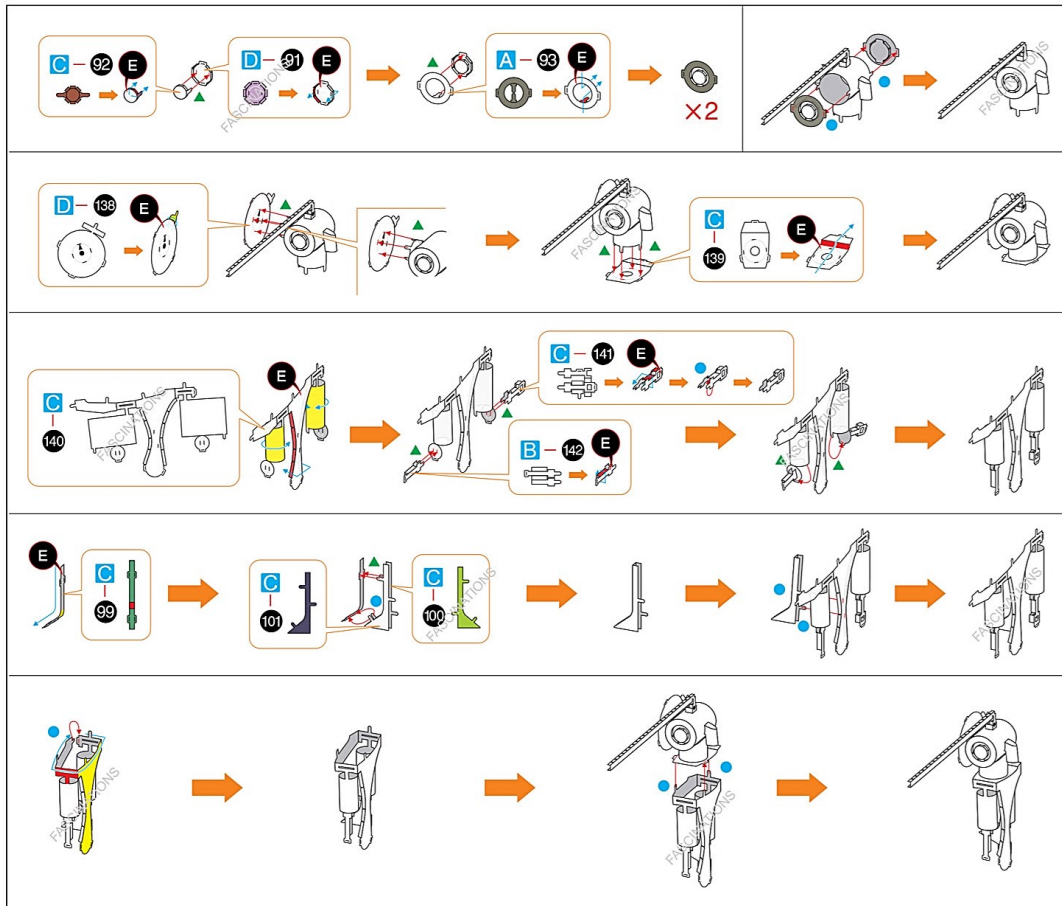

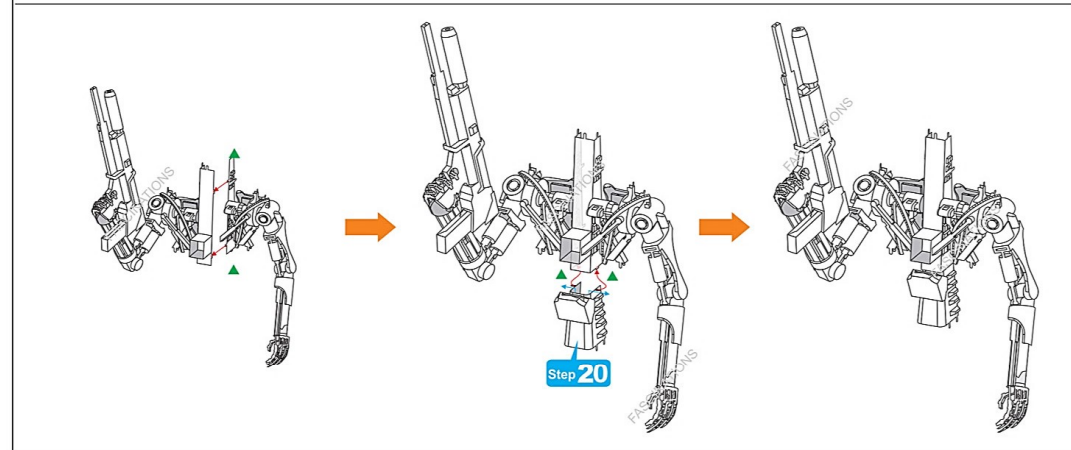
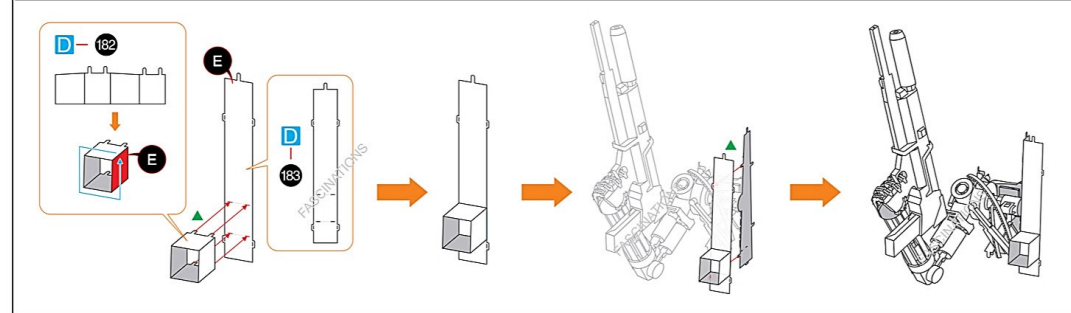
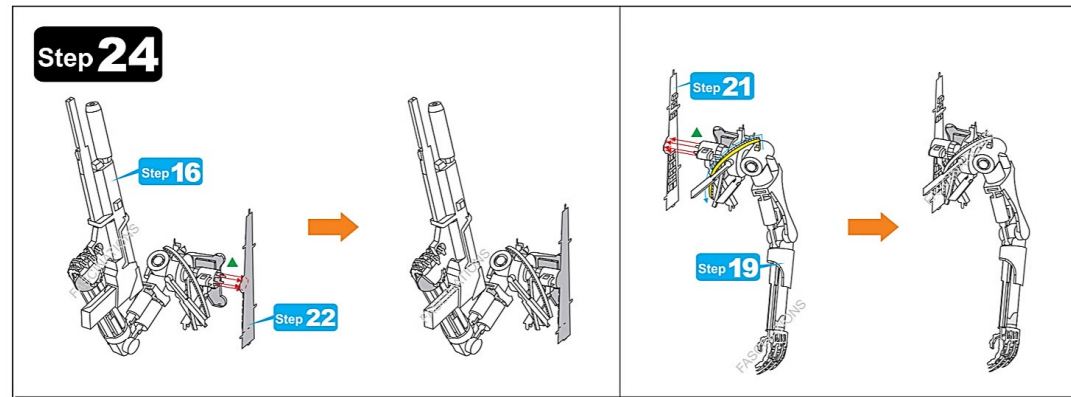
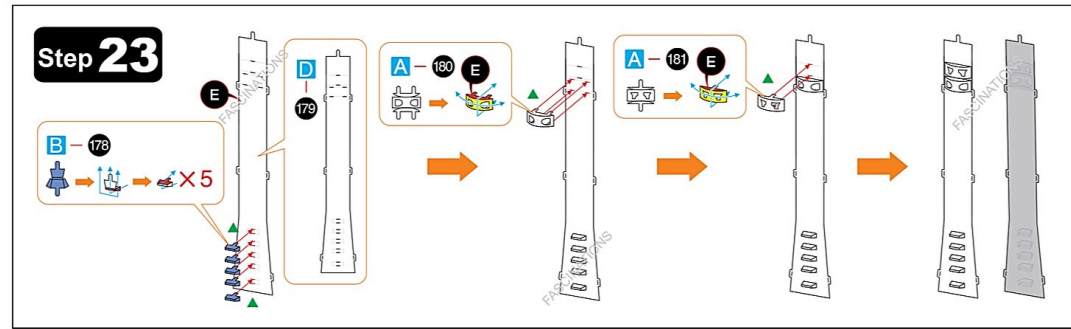
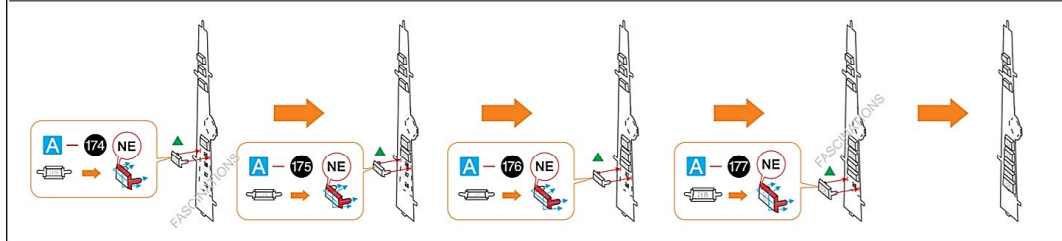
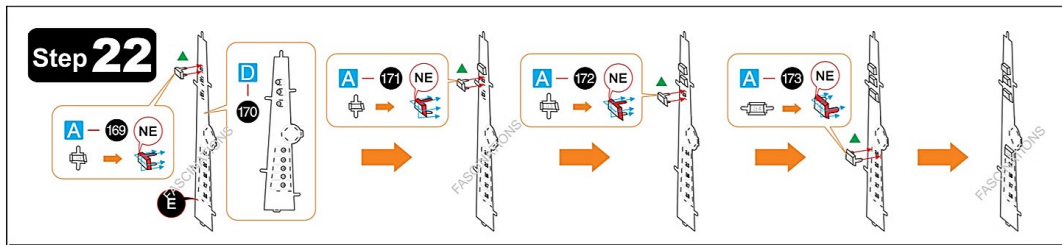
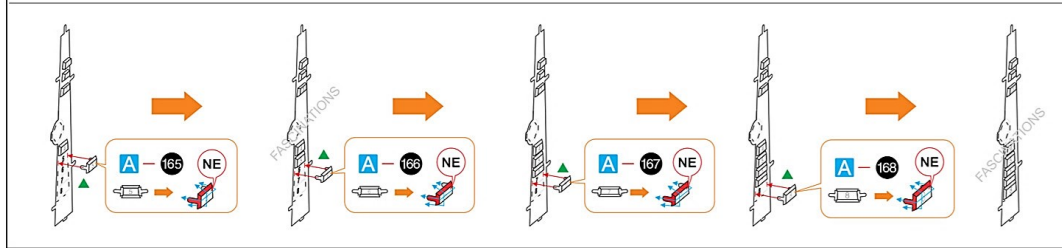
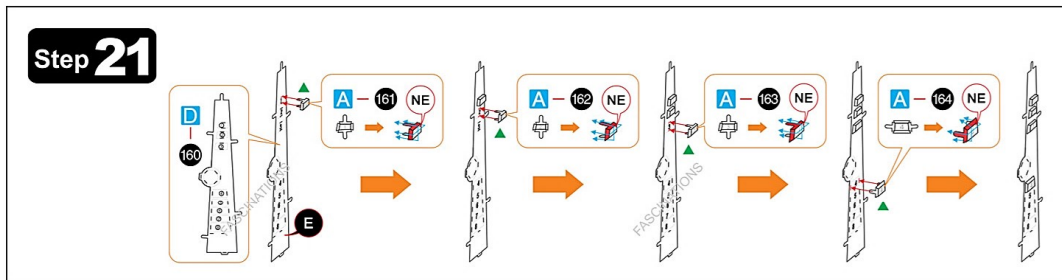
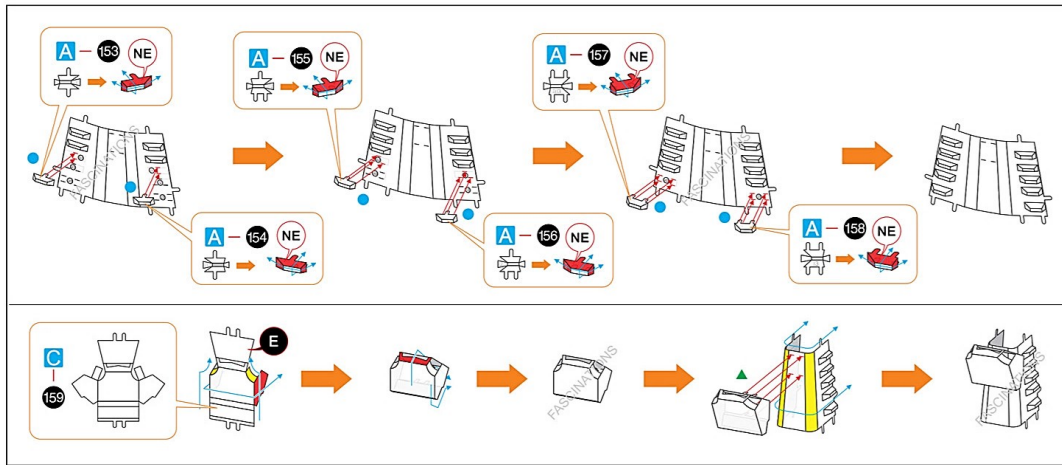

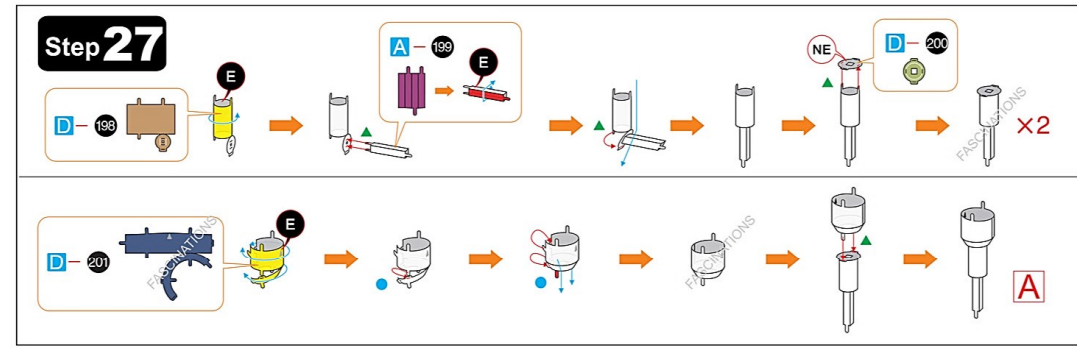
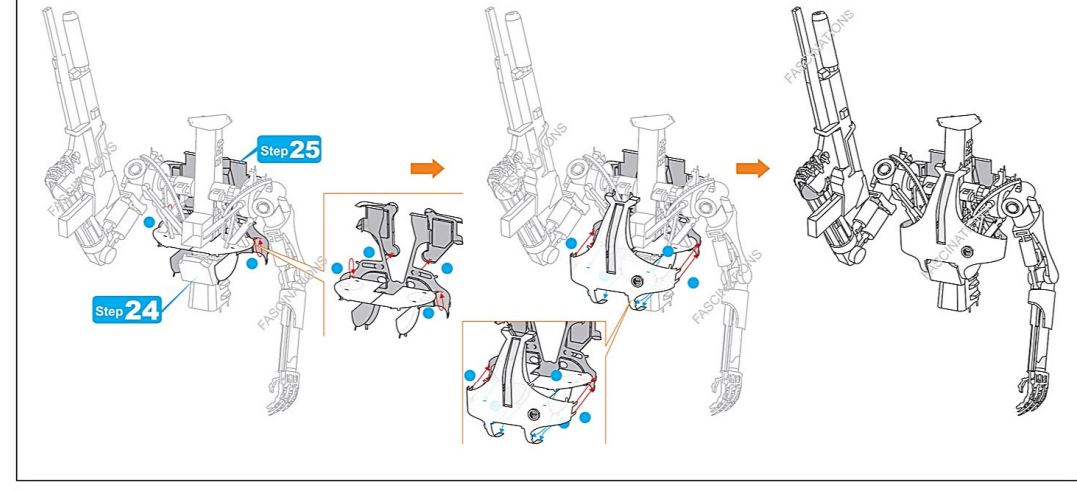
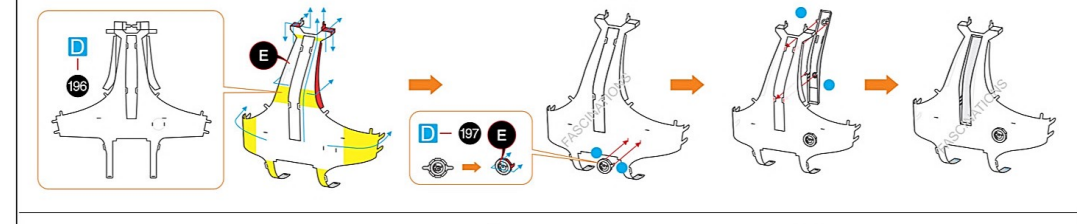
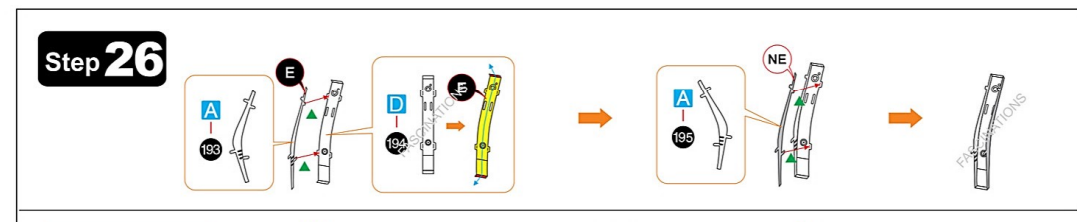
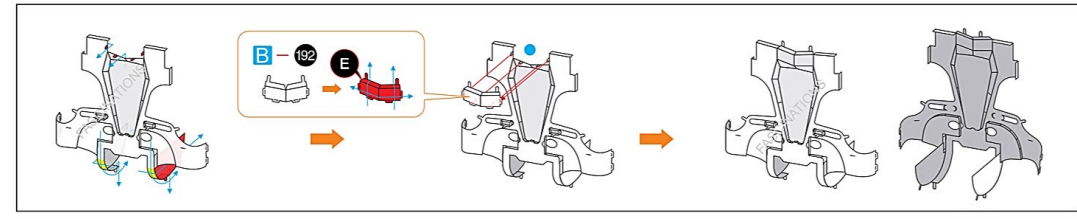
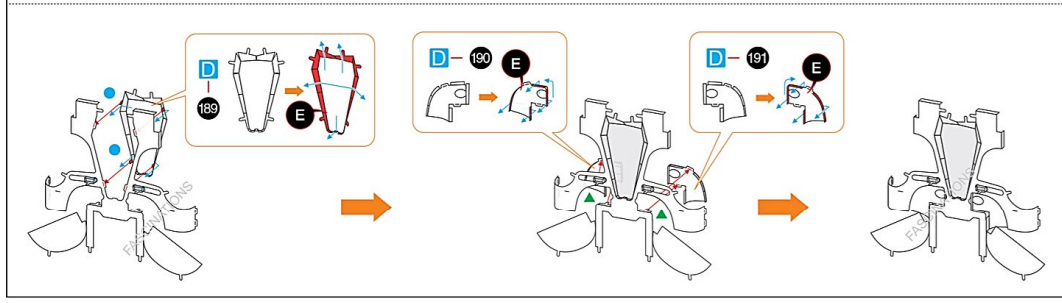
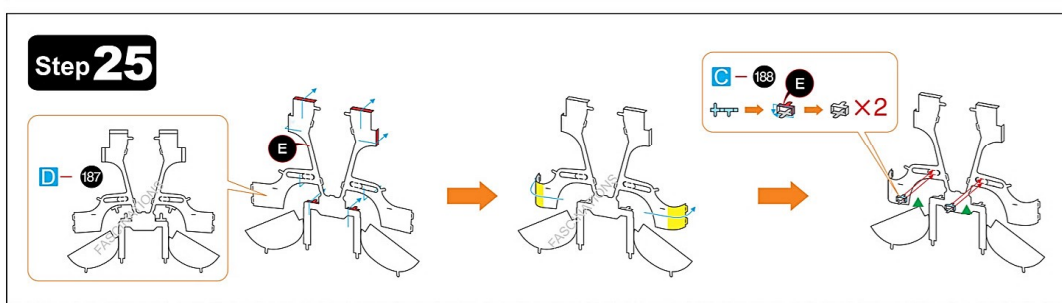
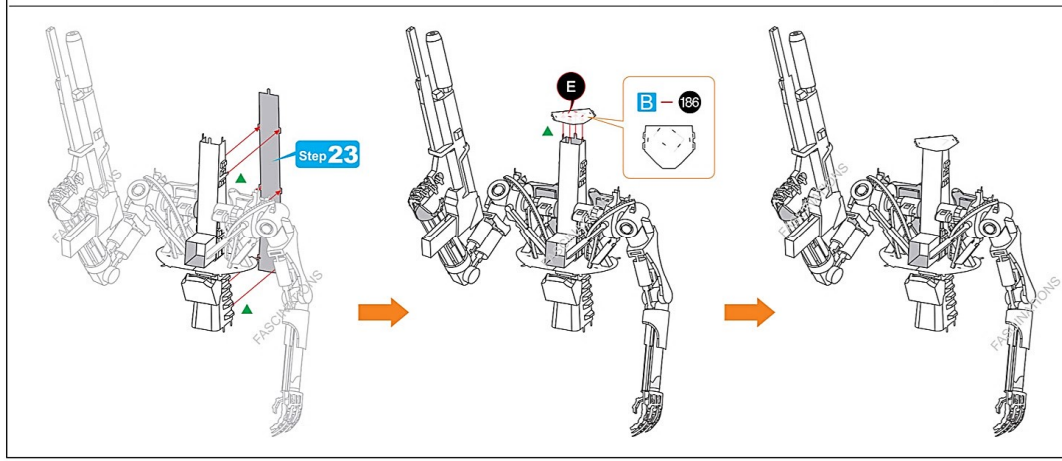
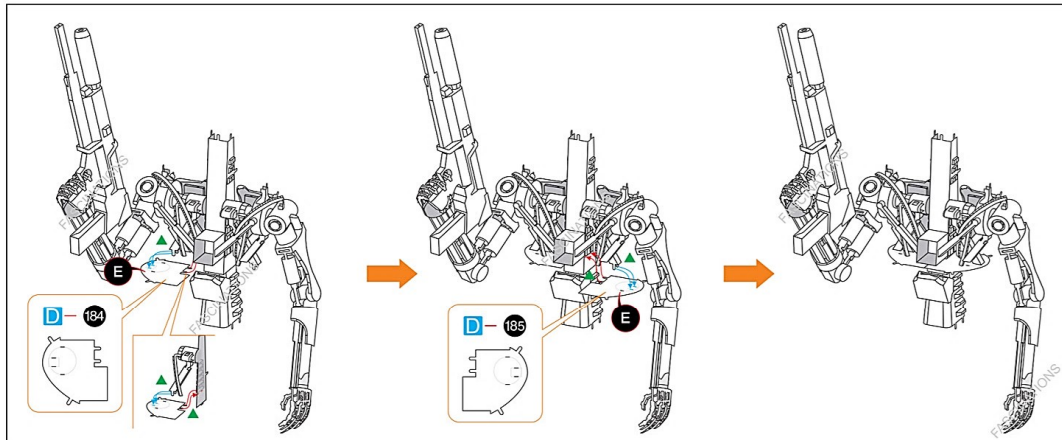

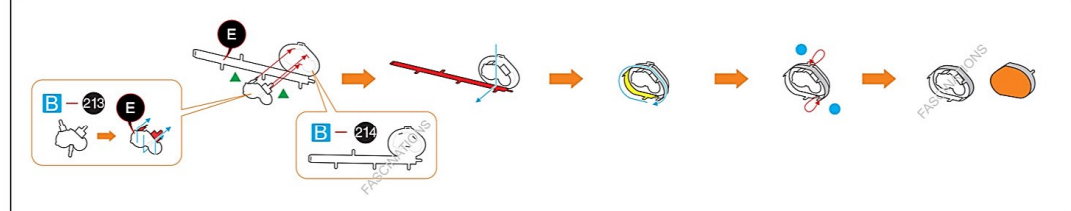
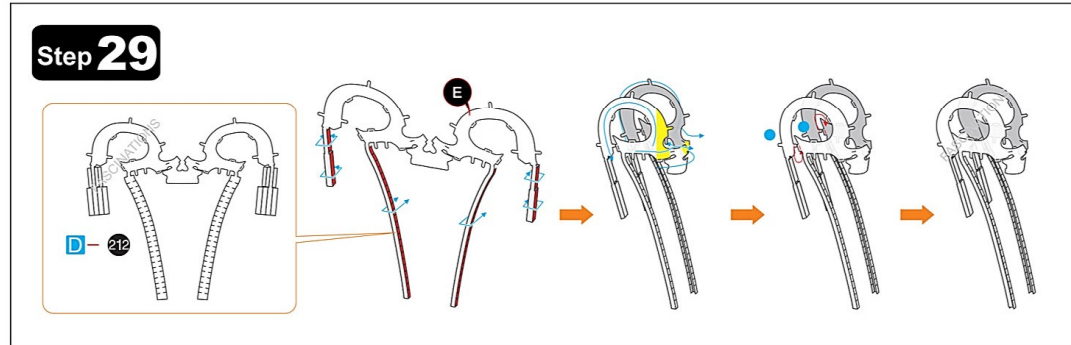
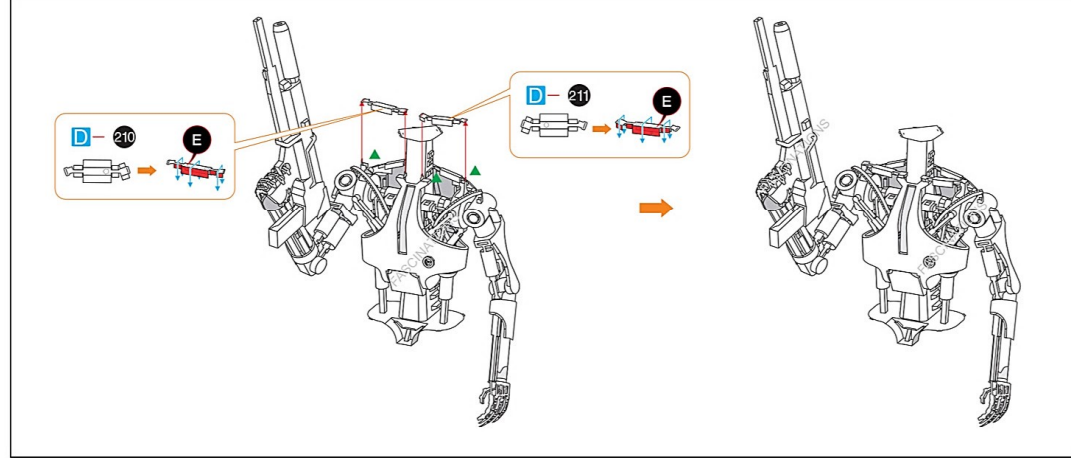
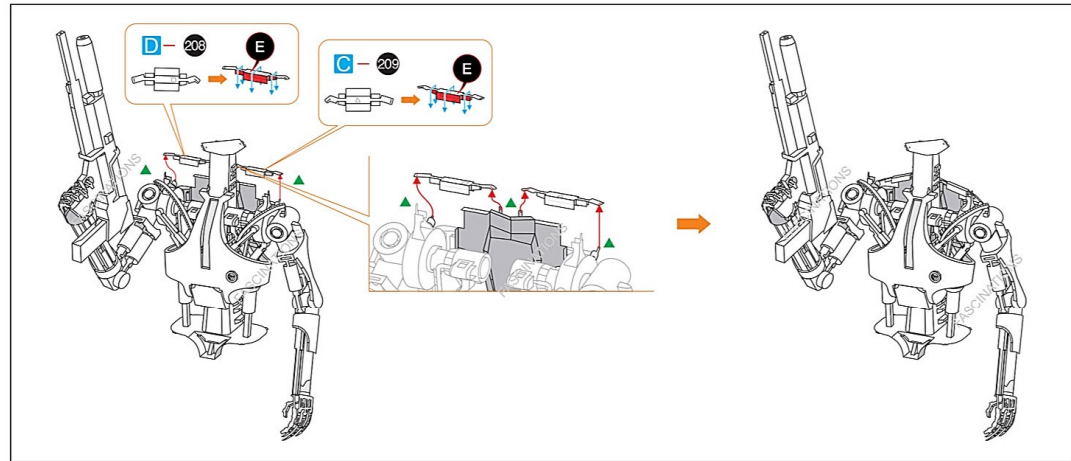
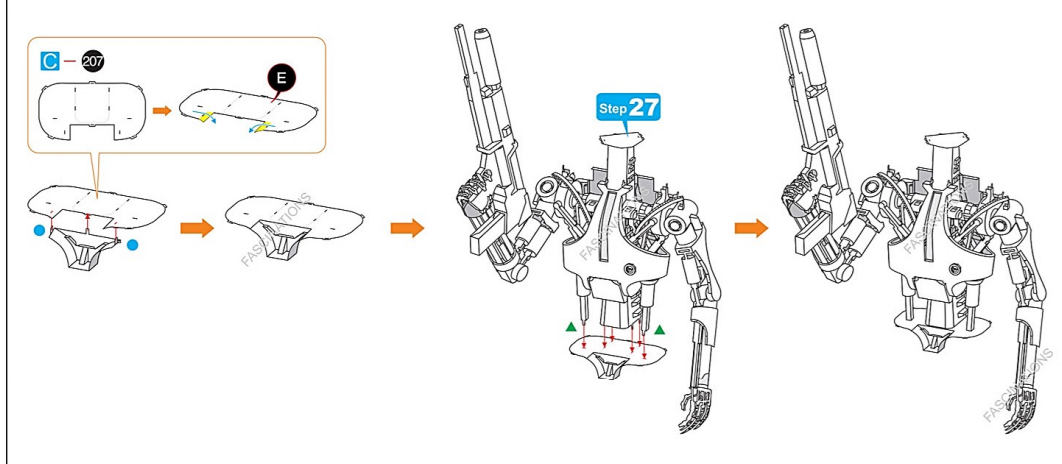
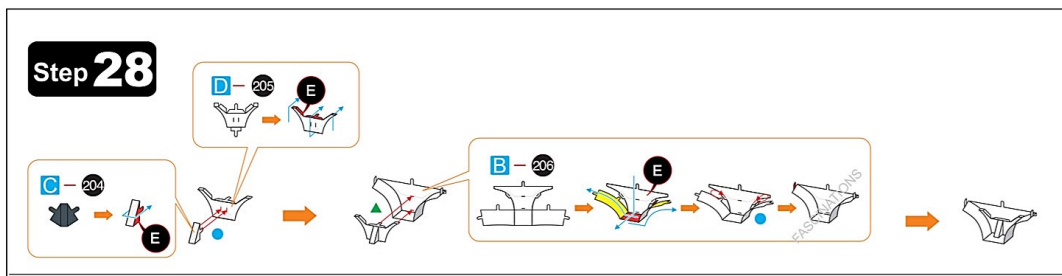
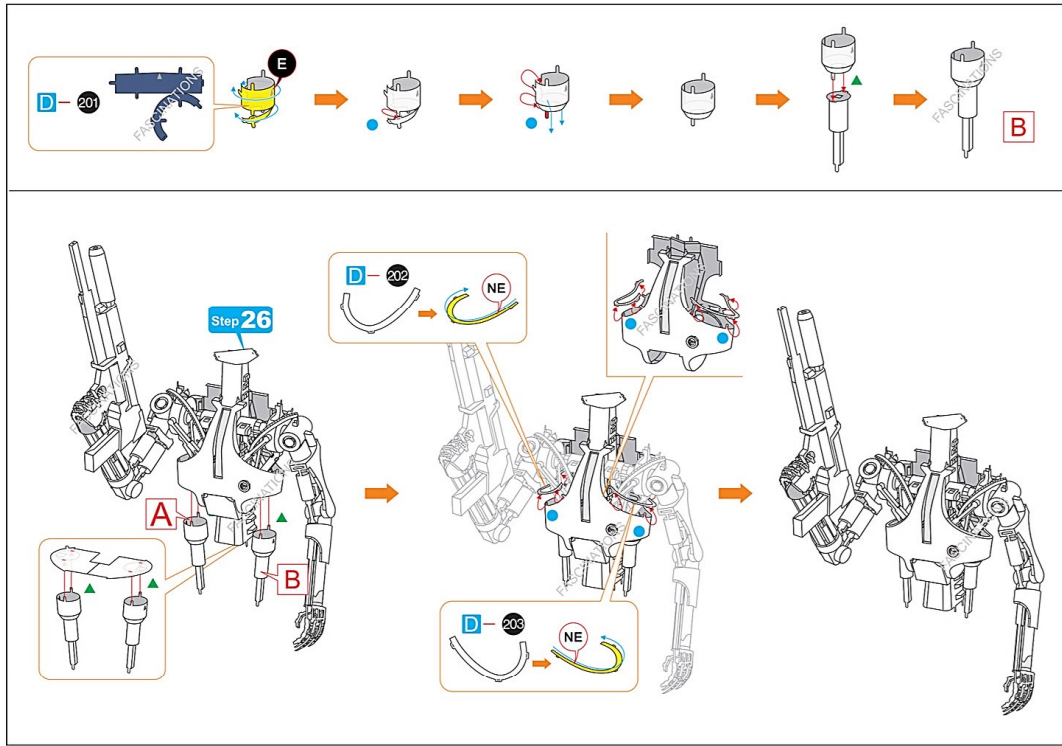

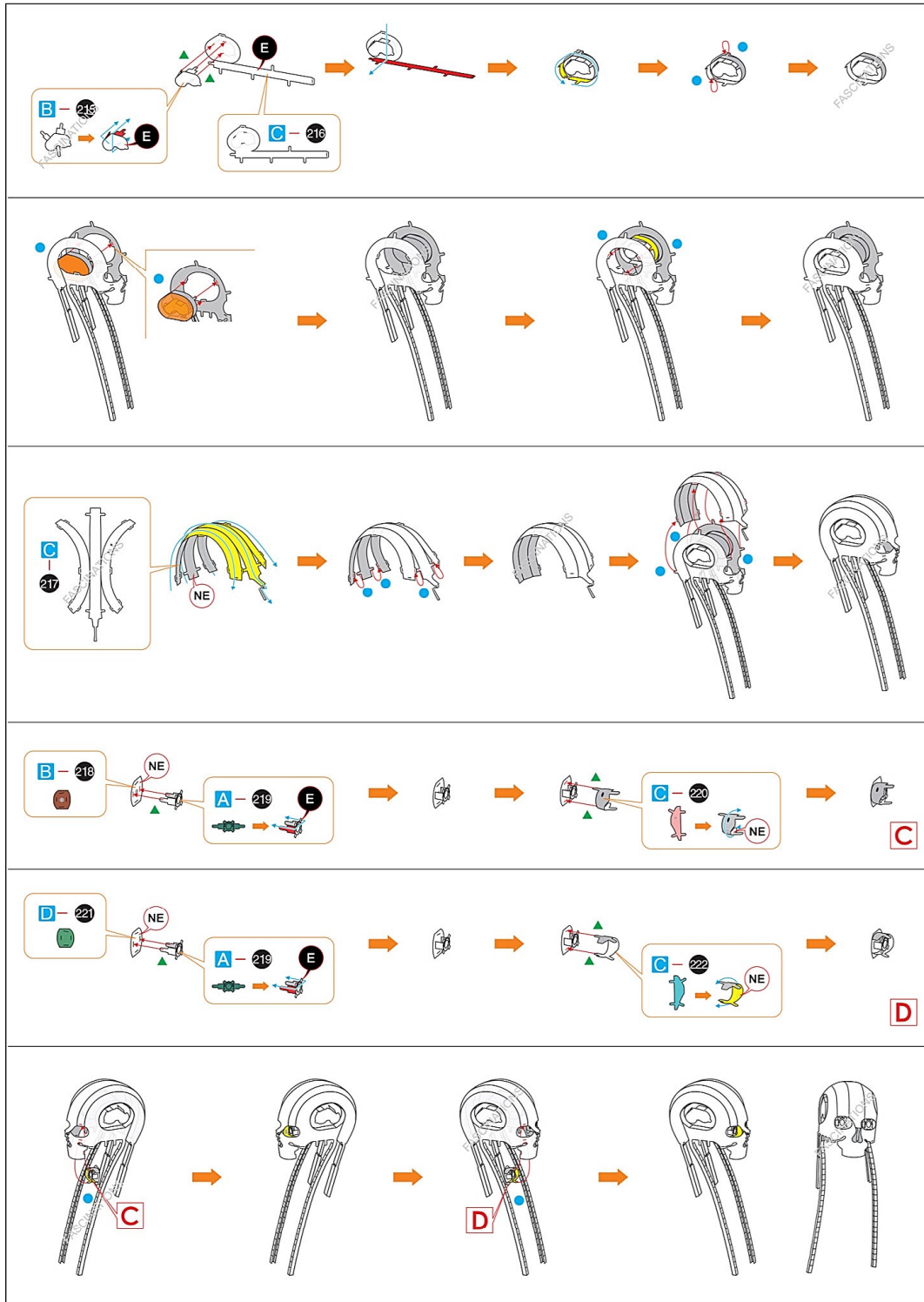

Step 30

